

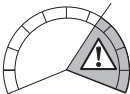





1



Kit 187119
FORD Transit, 4-dr Van, 15-



  **Max 130 km/h**
80 Mph

 +  = **Max: 100 kg**
7 kg / 220 lbs

  **80 km/h**
50 Mph 

 +  = **Max: 150 kg**
14 kg / 330 lbs

ISO 11154-E





This kit is only for vehicles with fixpoint mounting.

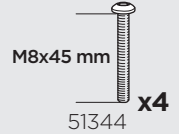
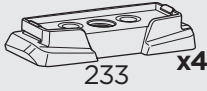
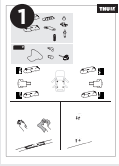

i

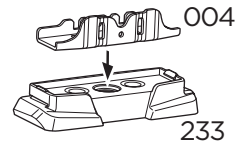
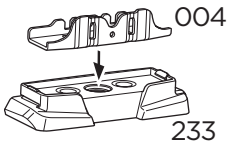
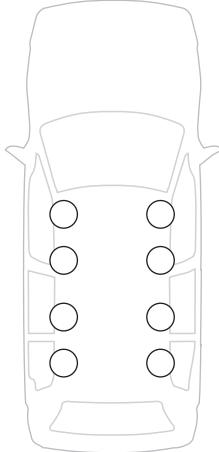
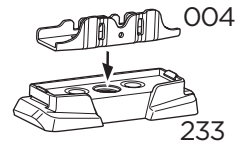
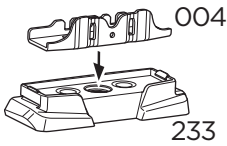

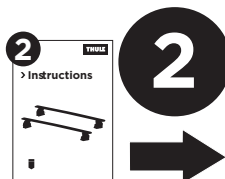
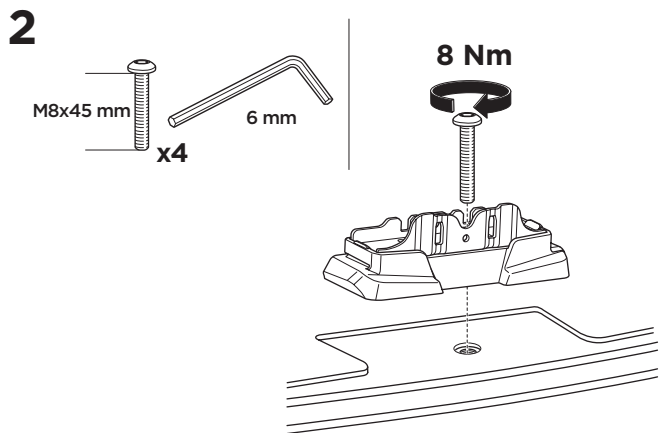
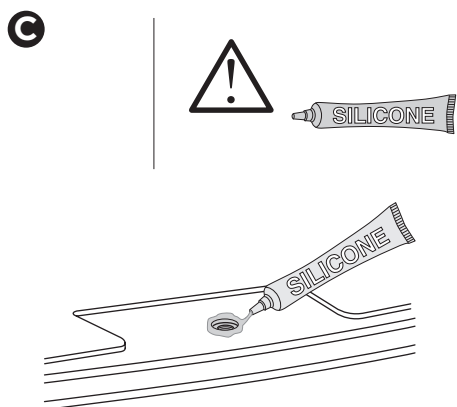
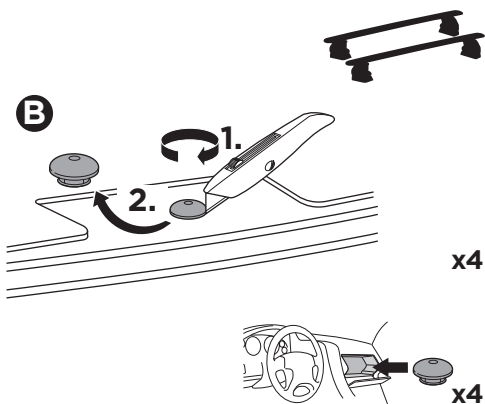
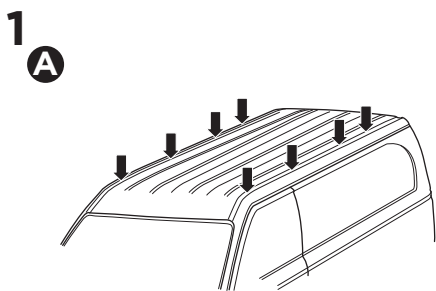



This kit is only for vehicles with fixpoint mounting.

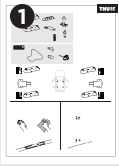

x2

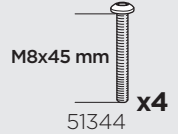
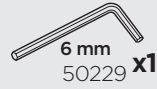
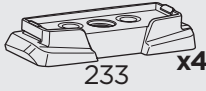

i

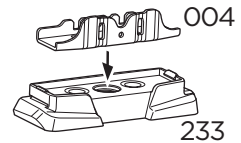
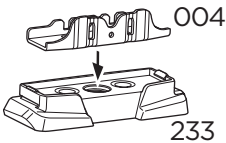
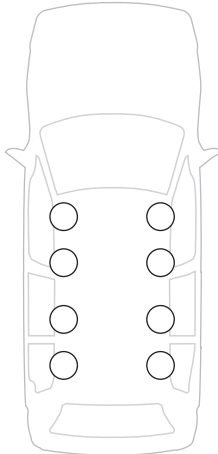
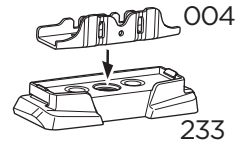
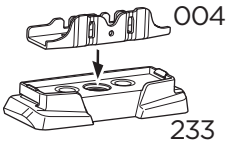

1 **A**

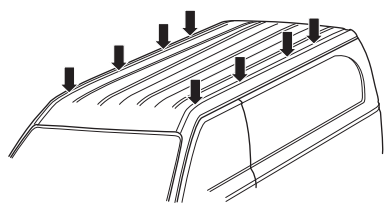

B

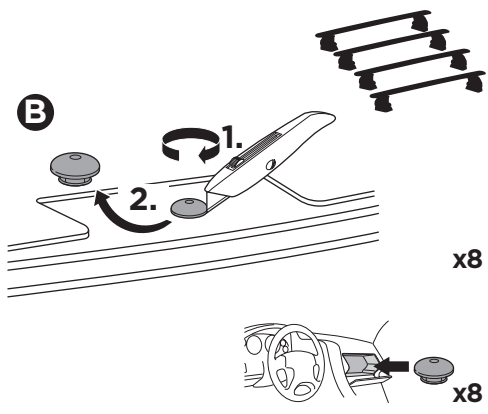

C

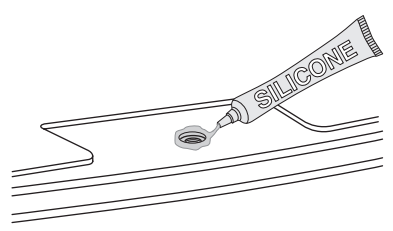

2

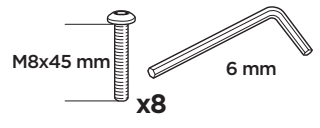

8 Nm

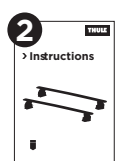
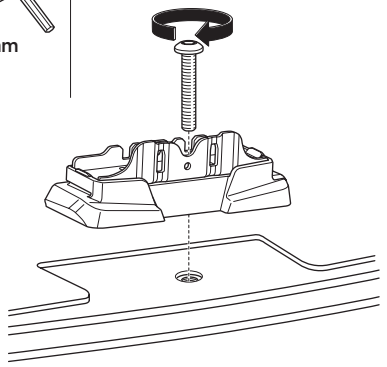

i



A

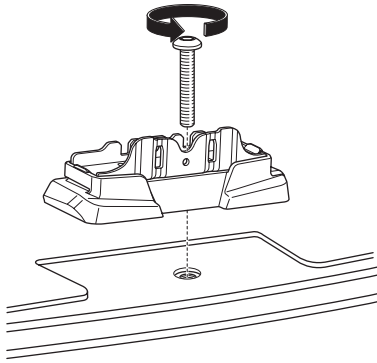

B

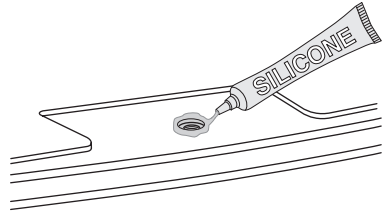

C

