

# 1

## Kit 145421

FORD Capri EV, 5-dr SUV, 25-



ISO 11154-E

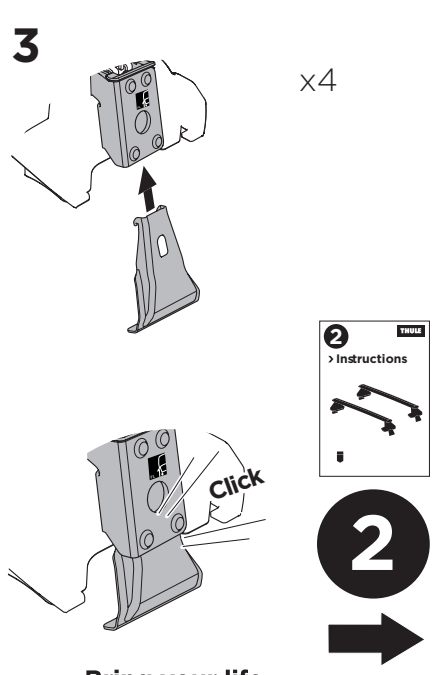
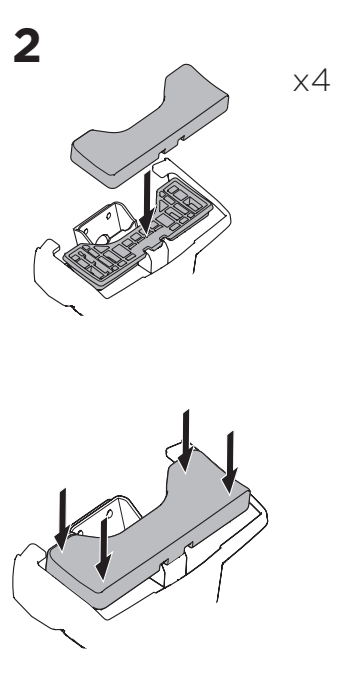
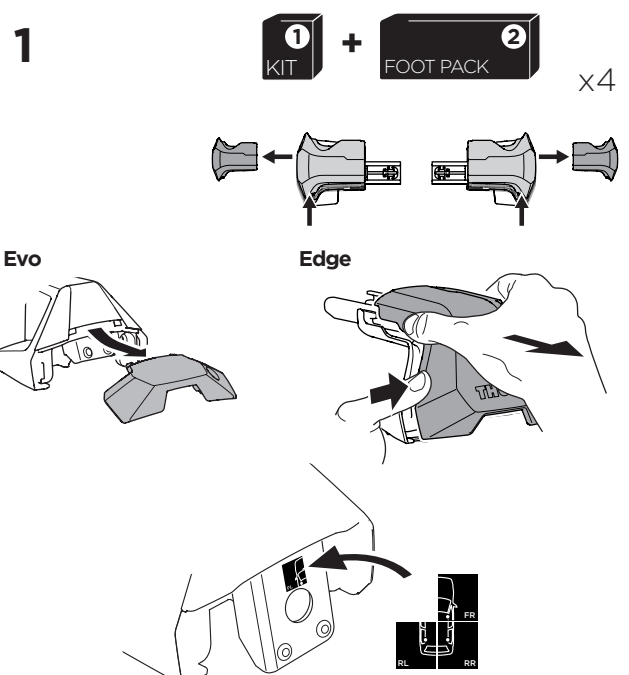
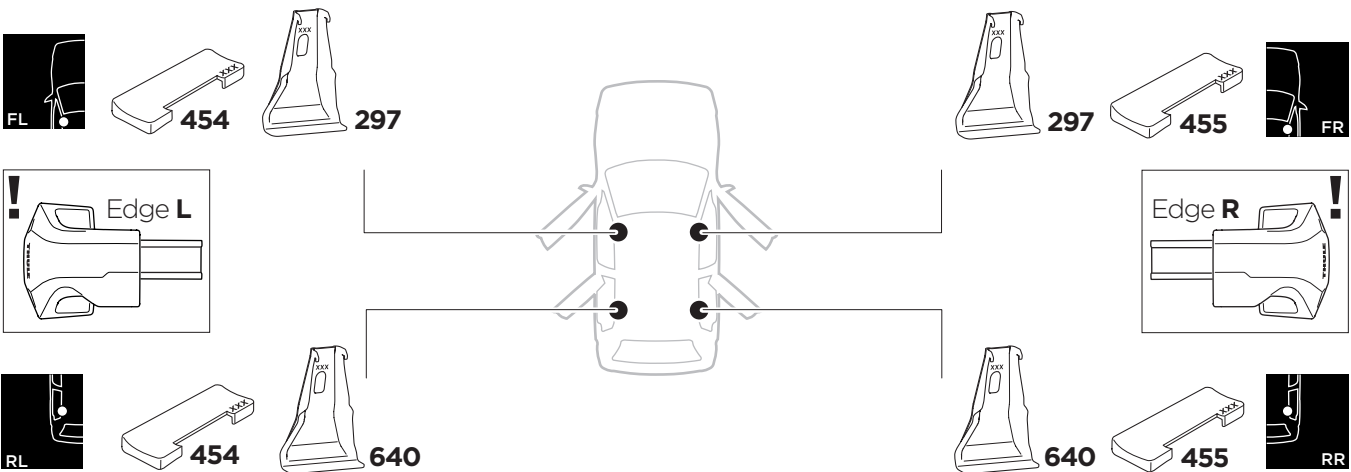
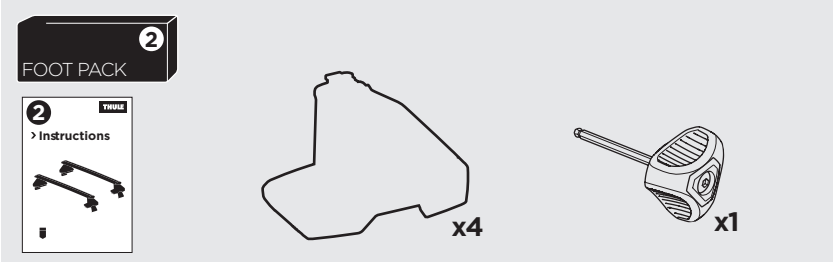
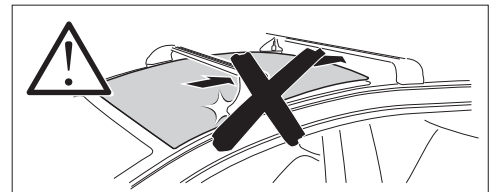
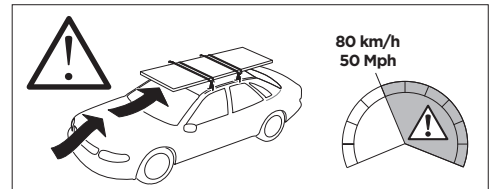
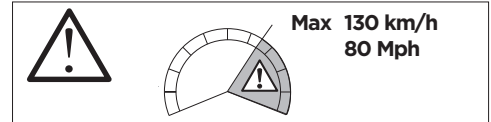
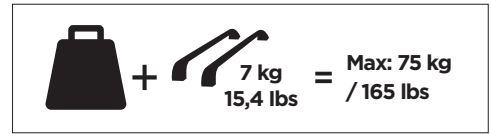
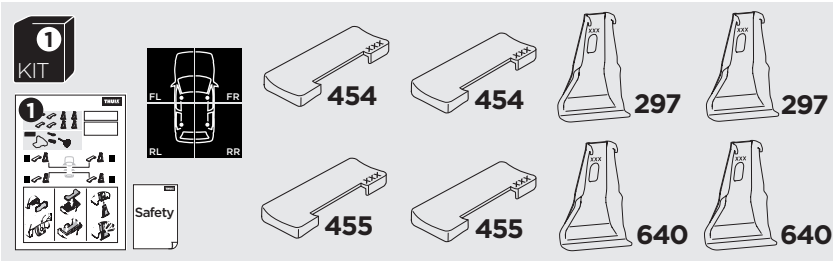

Bring your life  
thule.com



THULE WingBar Evo	THULE WingBar Edge	THULE WingBar	THULE SquareBar Evo	<b>Evo X (scale)</b>	<b>Edge X (scale)</b>
<b>FORD Capri EV, 5-dr SUV, 25-</b>				<b>42,5</b>	<b>L</b>
THULE ProBar Evo	THULE SlideBar Evo				<b>X (mm/inch)</b>
<b>FORD Capri EV, 5-dr SUV, 25-</b>				<b>1076 mm / 42 3/8"</b>	

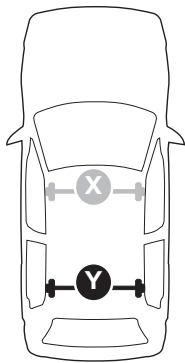

THULE WingBar Evo	THULE WingBar Edge	THULE WingBar	THULE SquareBar Evo	<b>Evo Y (scale)</b>	<b>Edge Y (scale)</b>
<b>FORD Capri EV, 5-dr SUV, 25-</b>				<b>39,5</b>	<b>R</b>
THULE ProBar Evo	THULE SlideBar Evo				<b>Y (mm/inch)</b>
<b>FORD Capri EV, 5-dr SUV, 25-</b>				<b>1046 mm / 41 1/8"</b>	

	<b>W (mm/inch)</b>	<b>Z (mm/inch)</b>
<b>FORD Capri EV, 5-dr SUV, 25-</b>	<b>775 mm / 30 1/2"</b>	<b>290 mm / 11 3/8"</b>

