



## Thule XT Kit 3143

# > Instructions

OPEL/ VAUXHALL Corsa E, 3-dr Hatchback, 15-19

OPEL/ VAUXHALL Corsa E, 5-dr Hatchback, 15-19

OPEL/ VAUXHALL Corsavan, 3-dr Van, 15-19

This kit is only for vehicles with fixpoint mounting.

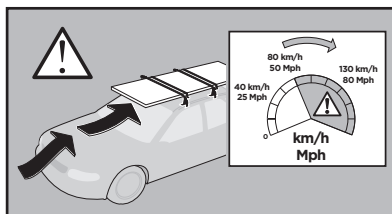
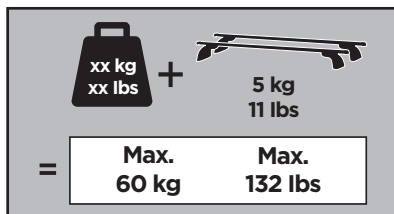
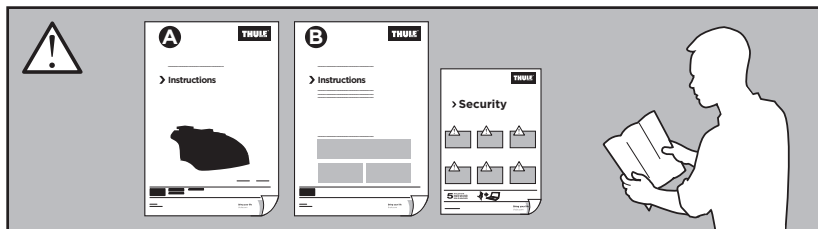

ISO 11154-E

183143

C.20200203  
509-3143-03

Bring your life  
thule.com

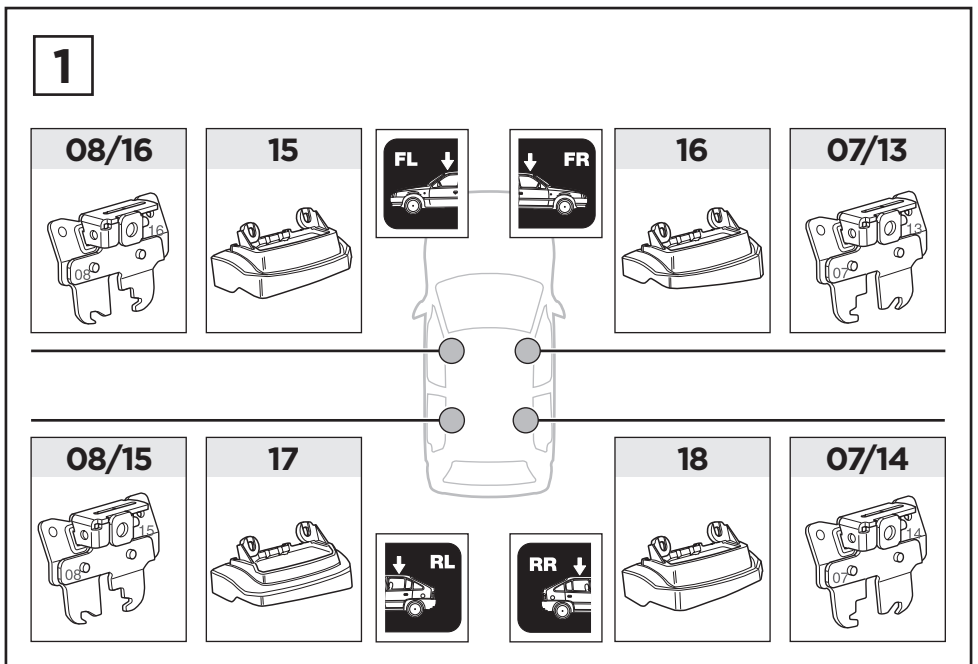
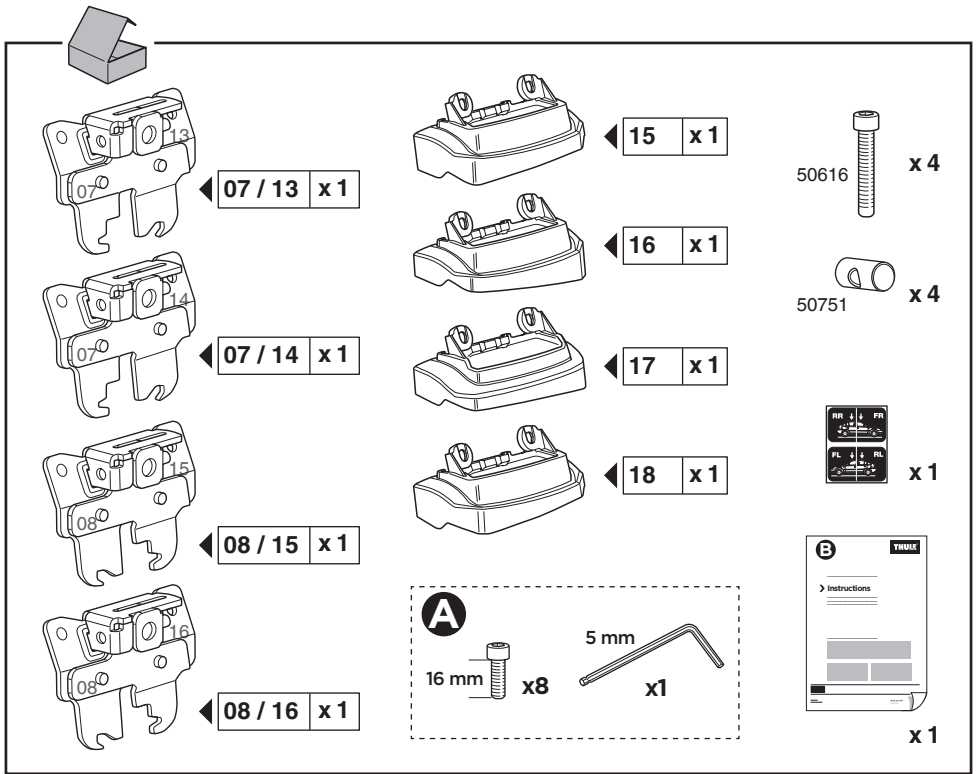

2

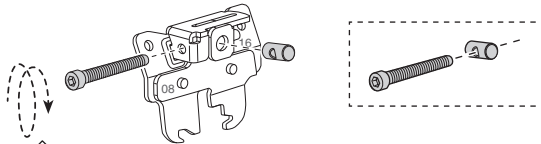
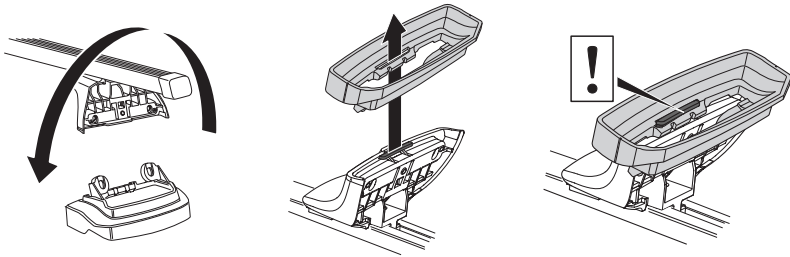

- |                                     |                                     |                                  |
|-------------------------------------|-------------------------------------|----------------------------------|
| <b>EN</b> Only a few turns          | <b>ET</b> Ainult mõni pööre         | <b>RO</b> Doar câteva rotiri     |
| <b>DE</b> Nur wenige Umdrehungen    | <b>LV</b> Tikai dažī apgriezieni    | <b>HU</b> Csak néhány fordítás   |
| <b>FR</b> Quelques tours uniquement | <b>LT</b> Tik keli pasukimai        | <b>EL</b> Μόνο λίγες περιστροφές |
| <b>NL</b> Slechts enkele slagen     | <b>PL</b> Wystarczy kilka obrotów   | <b>TR</b> Yalnızca birkaç tur    |
| <b>IT</b> Solo qualche giro         | <b>RU</b> Только несколько оборотов | <b>AR</b> بعض دورات فقط          |
| <b>ES</b> Sólo algunas vueltas      | <b>UK</b> Лише декілька обертів     | <b>HE</b> רק מספר סיבובים        |
| <b>PT</b> Apenas algumas voltas     | <b>BG</b> Само няколко завъртания   | <b>ZH</b> 仅几圈                    |
| <b>SV</b> Endast några varv         | <b>CS</b> Pouze několik otáček      | <b>JA</b> 2～3回転のみ                |
| <b>DK</b> Kun nogle få omgange      | <b>SK</b> Len niekoľko otáčok       | <b>KO</b> 몇 번만 돌리면 됨             |
| <b>NO</b> Bare noen få omdreinger   | <b>SL</b> Le nekaj obratov          | <b>TH</b> เพียงสองสามรอบ         |
| <b>FI</b> Vain muutama kierros      | <b>HR/BIH</b> Samo nekoliko okreta  |                                  |

A

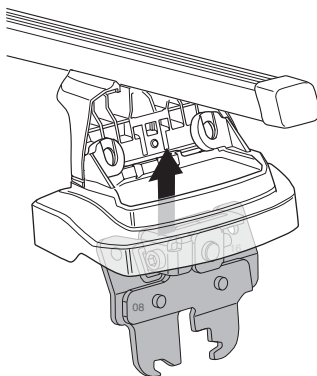

B

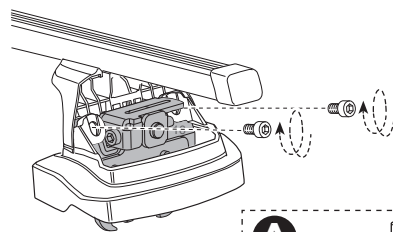

C

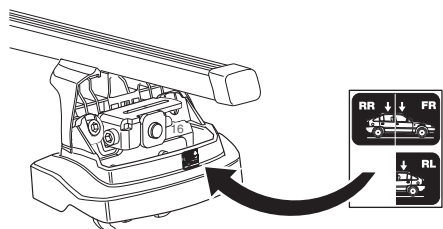

x 1

**3**

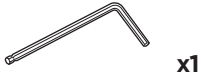

**A**

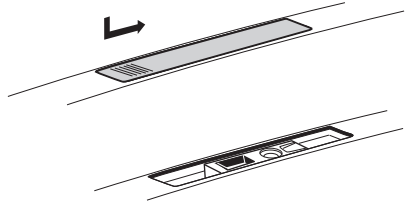
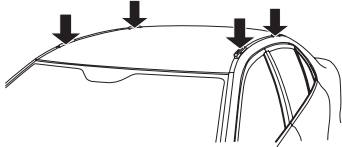

**B**

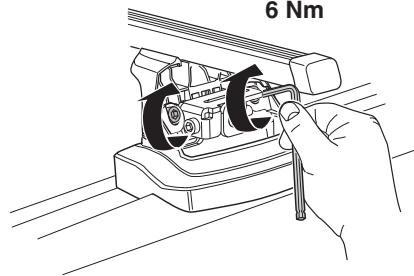
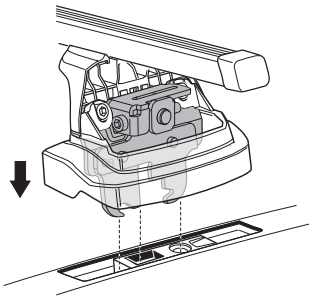

**C**

