

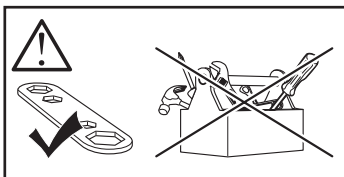

## Thule XT Kit 3181

# > Instructions

KIA Seltos, 5-dr SUV, 20-



This kit is only for vehicles with fixpoint mounting.

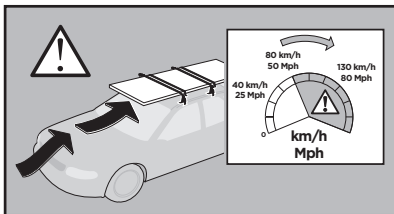
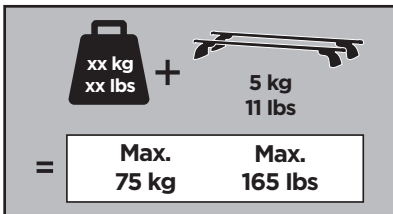
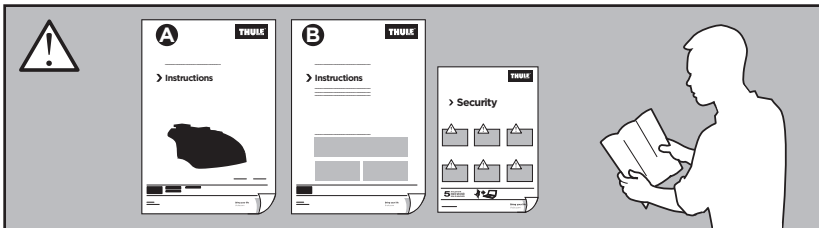

ISO 11154-E

183181

C.20200313  
5560058001

Bring your life  
thule.com

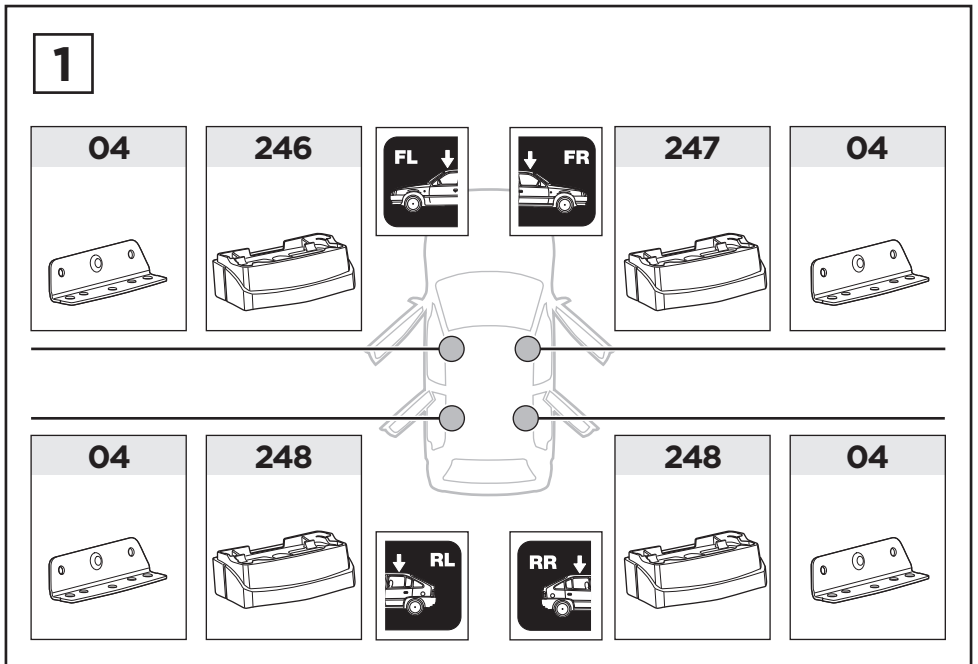
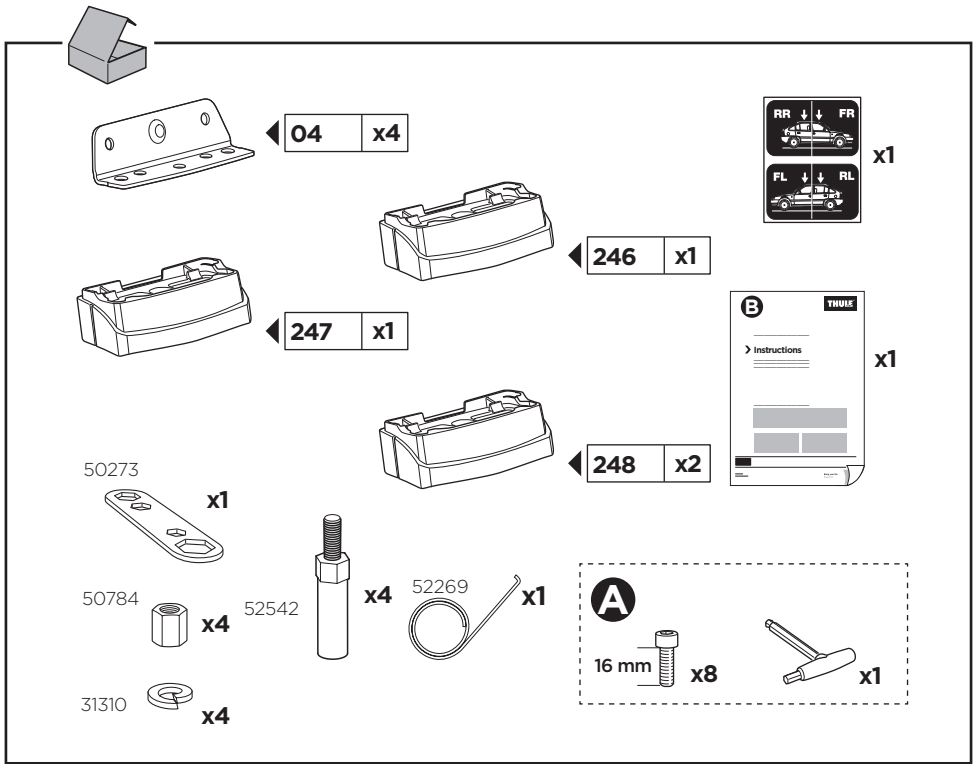

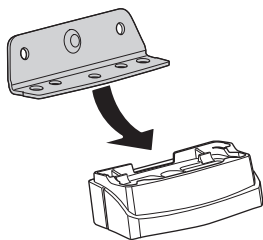
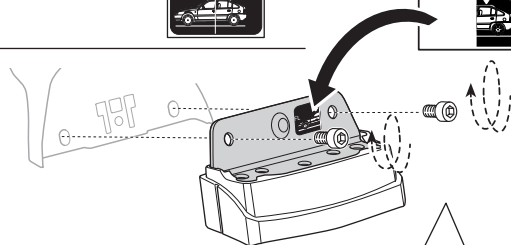
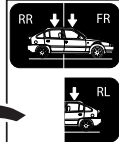
**2** A**B** **A** 16 mm x8

<b>EN</b> Only a few turns	<b>ET</b> Ainult mõni pööre	<b>RO</b> Doar câteva rotiri	<b>AR</b> بعض دورات فقط
<b>DE</b> Nur wenige Umdrehungen	<b>LV</b> Tikai daži apgriezieni	<b>HU</b> Csak néhány fordítás	<b>HE</b> רק מספר סבובים
<b>FR</b> Quelques tours uniquement	<b>LT</b> Tik keli pasukimai	<b>EL</b> Μόνο λίγες περιστροφές	
<b>NL</b> Slechts enkele slagen	<b>PL</b> Wystarczy kilka obrotów	<b>TR</b> Yalnızca birkaç tur	
<b>IT</b> Solo qualche giro	<b>RU</b> Только несколько оборотов		
<b>ES</b> Sólo algunas vueltas	<b>UK</b> Лише декілька обертів	<b>ZH</b> 仅几圈	
<b>PT</b> Noções básicas	<b>BG</b> Само няколко завъртания	<b>JA</b> 2 ~ 3 回転のみ	
<b>SV</b> Endast några varv	<b>CS</b> Pouze několik otáček	<b>KO</b> 몇 번만 돌리면 됨	
<b>DK</b> Kun nogle få omgange	<b>SK</b> Len niekoľko otáčok	<b>TH</b> เพียงสองสามรอบ	
<b>NO</b> Bare noen få omdreininger	<b>SL</b> Le nekaj obratov		
<b>FI</b> Vain muutama kierros	<b>HR/BiH</b> Samo nekoliko okreta		

**3**