

# > Instructions

Thule Epos 2-bike  
903210

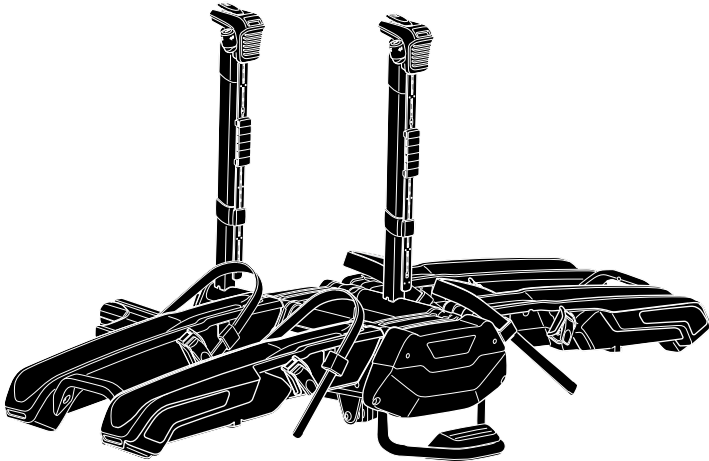



**EN**

## HITCH BIKE RACKS

FAILURE TO COMPLY WITH THE MANUFACTURER'S INSTRUCTIONS CAN LEAD TO SERIOUS INJURY OR DEATH.

**IMPORTANT** - READ CAREFULLY AND KEEP FOR FUTURE REFERENCE.

 **WARNING** INDICATES A HAZARDOUS SITUATION WHICH, IF NOT AVOIDED, COULD RESULT IN DEATH OR SERIOUS INJURY.

 **NOTE** INDICATES ADDITIONAL INFORMATION THAT IS USEFUL FOR TROUBLE-FREE AND OPTIMAL USE OF THE PRODUCT.

**FR**

## PORTE-VÉLOS SUR ATTELAGE

LE NON-RESPECT DES INSTRUCTIONS DU FABRICANT PEUT ENTRAÎNER DES BLESSURES GRAVES OU LA MORT.

**IMPORTANT** - LISEZ ATTENTIVEMENT CES INSTRUCTIONS ET CONSERVEZ-LES POUR RÉFÉRENCE FUTURE..

 **AVERTISSEMENT** INDIQUE UNE SITUATION POTENTIELLEMENT DANGEREUSE QUI, SI ELLE N'EST PAS ÉVITÉE, POURRAIT PROVOQUER DES BLESSURES GRAVES, VOIR MORTELLES.

 **REMARQUE** INDIQUE COMMENT RÉPONDRE À UNE SITUATION DONNÉE U VOUS DONNENT DES CONSEILS SUR LE FONCTIONNEMENT DES OPTIONS DISPONIBLES.

**ES**

## PORTABICICLETAS PARA ENGANCHE

EL INCUMPLIMIENTO DE LAS INSTRUCCIONES DEL FABRICANTE PUEDE PROVOCAR LESIONES GRAVES O LA MUERTE.

**IMPORTANTE** - LEA ATENTAMENTE Y CONSÉRVELO PARA FUTURAS CONSULTAS.

 **ADVERTENCIA** INDICA UNA SITUACIÓN DE PELIGRO QUE, SI NO SE EVITA, PODRÍA PROVOCAR LESIONES GRAVES O INCLUSO LA MUERTE.

 **NOTA** INDICA INFORMACIÓN ADICIONAL QUE ES ÚTIL PARA UN USO ÓPTIMO Y SIN PROBLEMAS DEL PRODUCTO.

**PT**

## SUPORTE PARA BICICLETA DE ENGATE AMERICANO

O NÃO CUMPRIMENTO DAS INSTRUÇÕES DO FABRICANTE PODE LEVAR A FERIMENTOS GRAVES OU À MORTE.

**IMPORTANTE** - LEIA COM ATENÇÃO E GUARDE PARA REFERÊNCIA FUTURA

 **ATENÇÃO** INDICA UMA SITUAÇÃO PERIGOSA QUE, SE NÃO FOR EVITADA, PODE RESULTAR EM MORTE OU FERIMENTOS GRAVES.

 **NOTA** INDICA INFORMAÇÕES ADICIONAIS QUE SÃO ÚTEIS PARA O USO IDEAL E SEM PROBLEMAS DO PRODUTO.

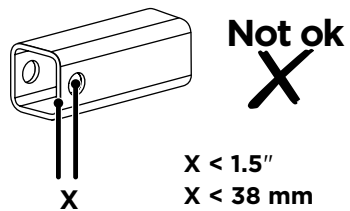
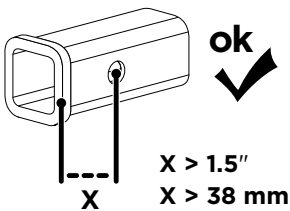
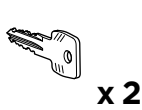
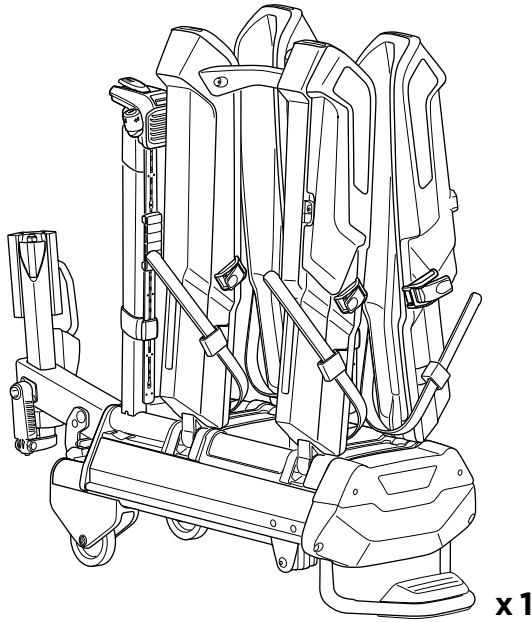

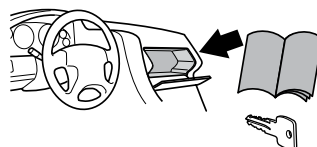
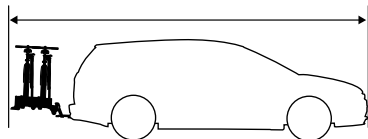
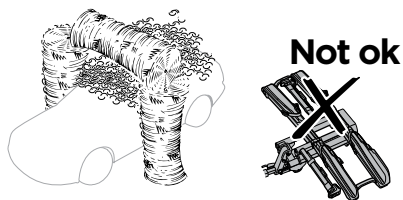
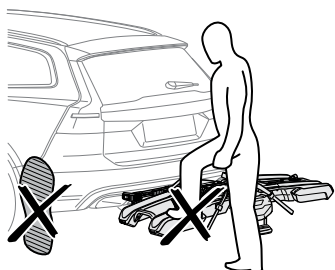
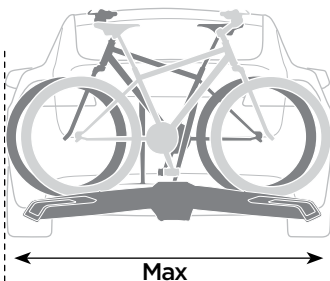
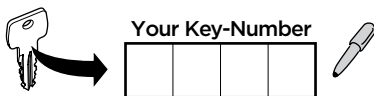
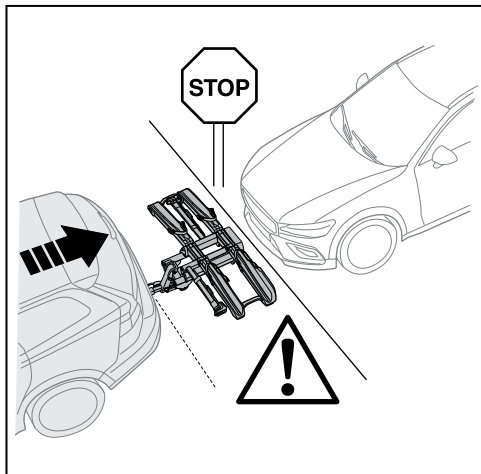

Load capacity  
Capacité  
Capacidad de carga  
Capacidade de carga



Max 75 lbs. (34 kg)



Max 140 lbs. (64 kg)



38.1 lbs. (17.3 kg)



ok ✓



ok ✓



Not ok ✗



Not ok ✗



16" min and 29" max



Max 53" wheelbase



3" max

Thule XXL Fatbike Wheel Straps  
9851

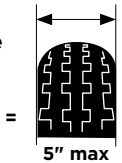

5" max

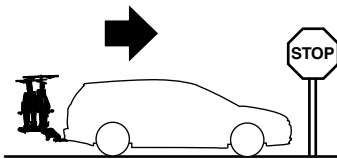

300 miles  
500 km

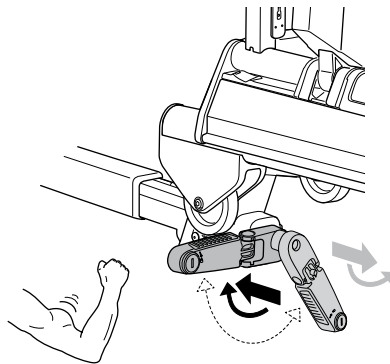

7.5 lb ft  
10 Nm

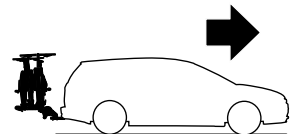

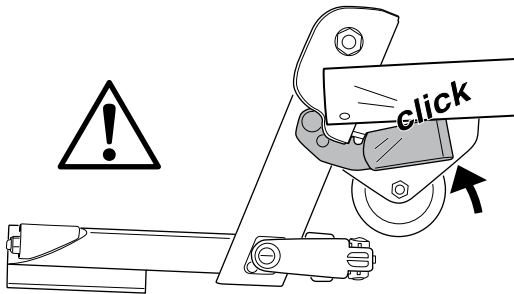
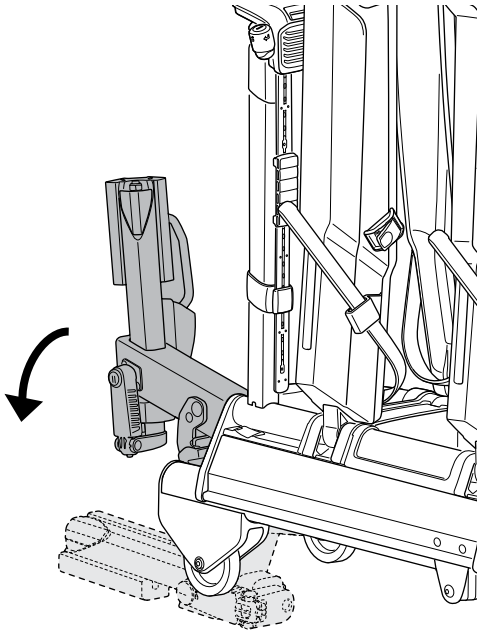

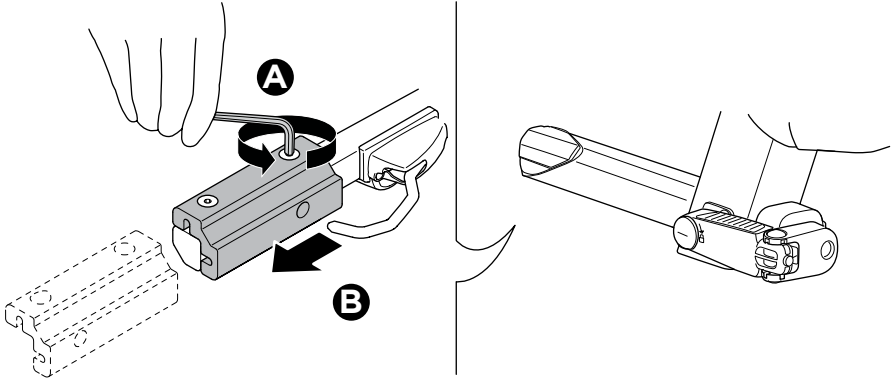
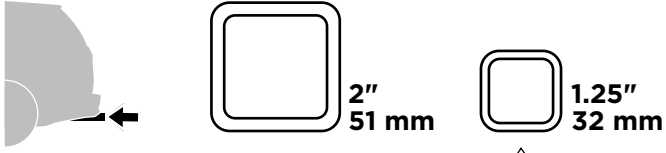

2

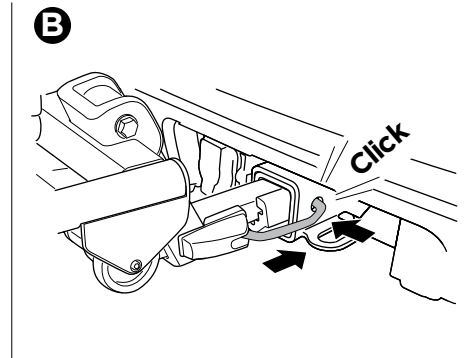
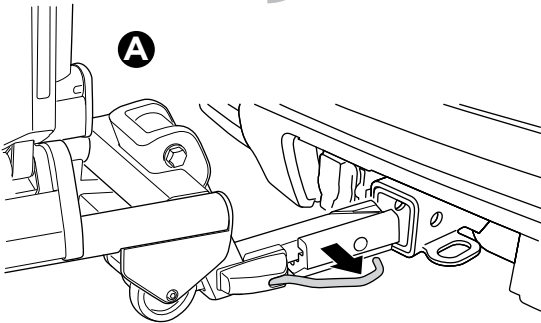
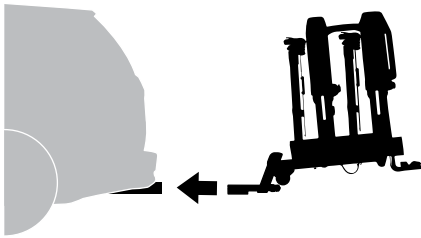

### 3

A

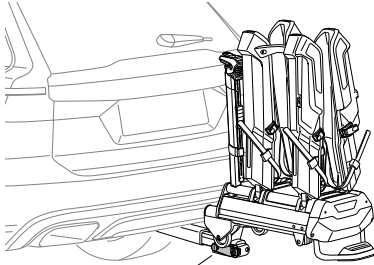

B

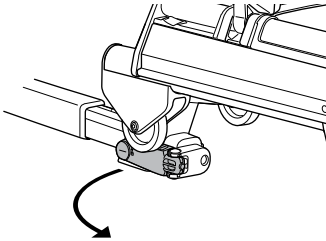

C

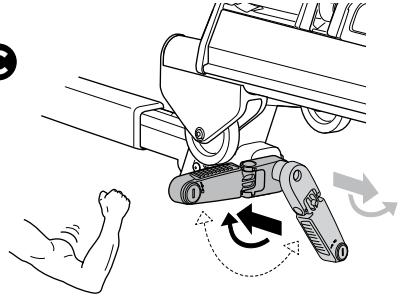

7.5 lb ft  
10 Nm

D

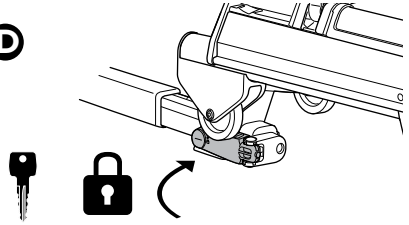

### 4

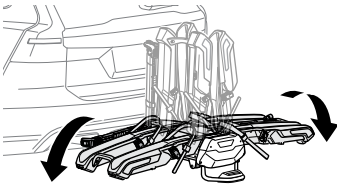

Not ok

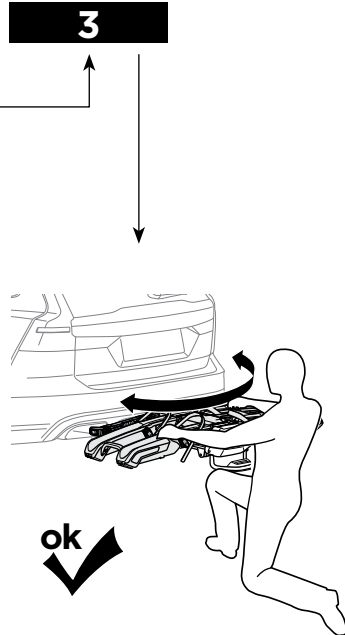

ok



# 5

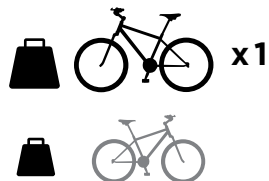
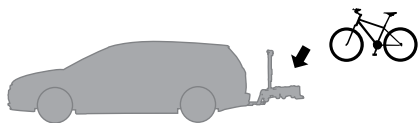
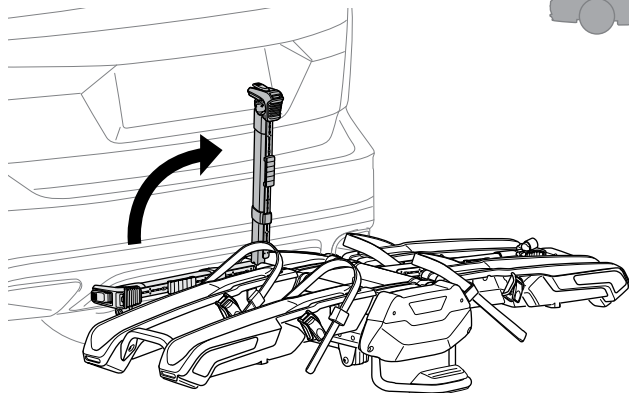

0.8-3.5"  
20-90mm

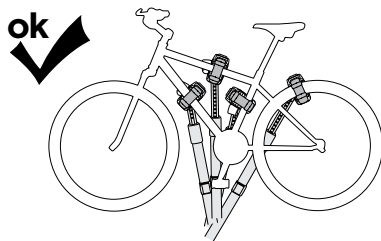
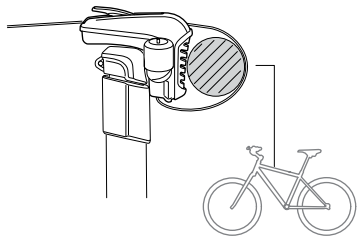

Not ok

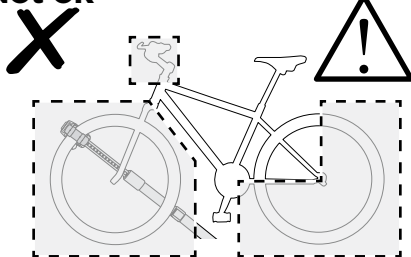

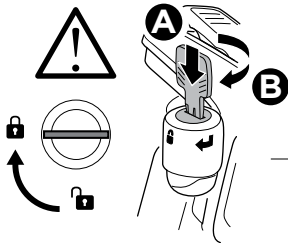
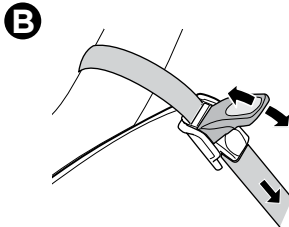
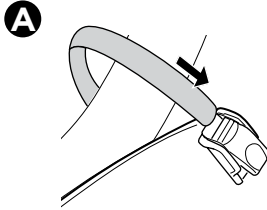
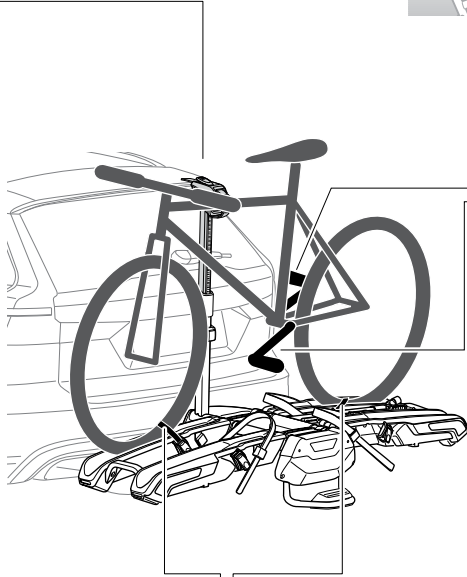
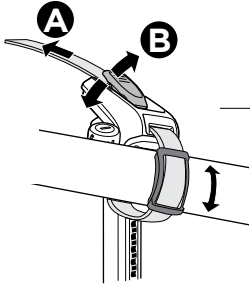
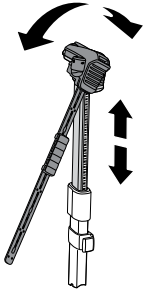
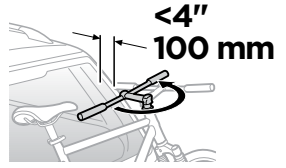

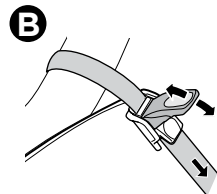
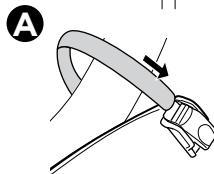
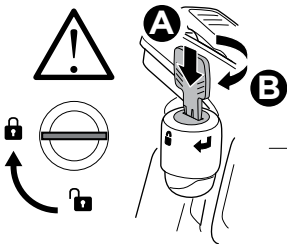
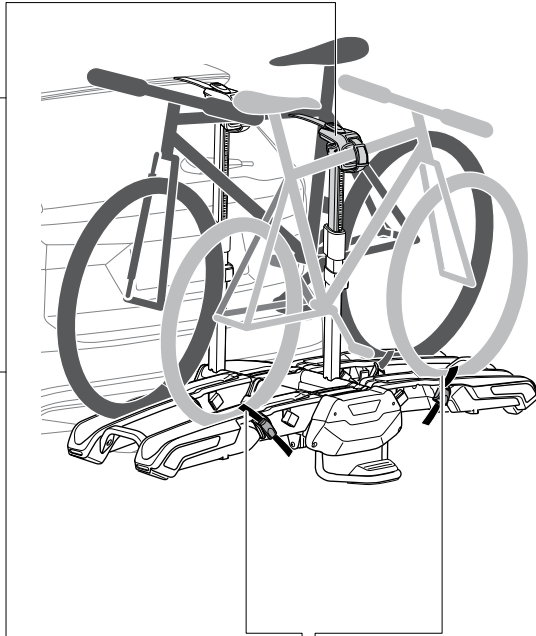
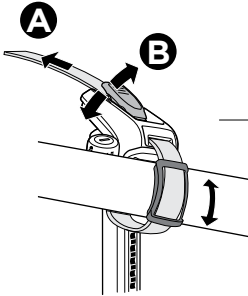
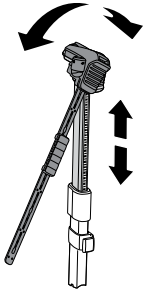
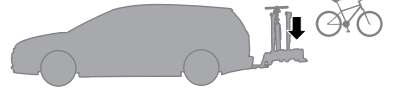
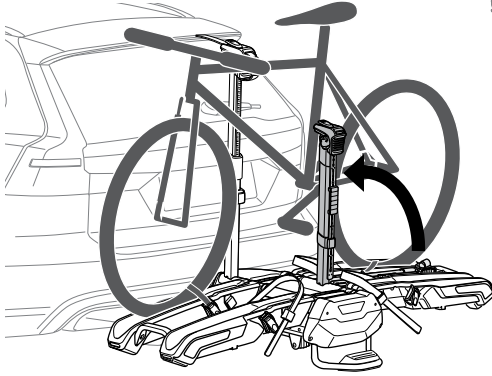

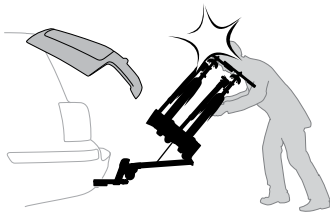
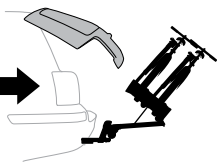
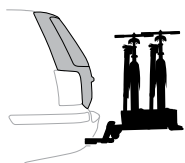

7

ok  
✓

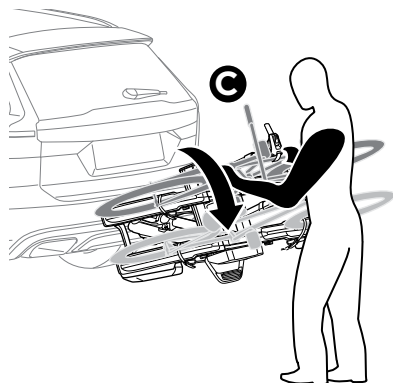
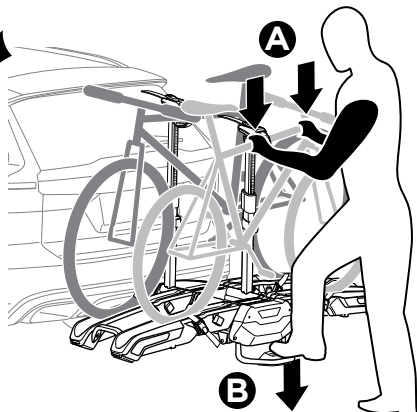

Not ok  
✗

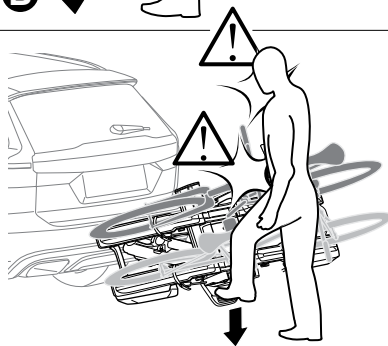

8

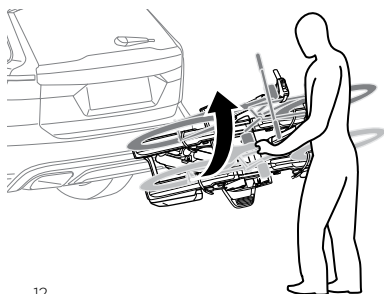

Click

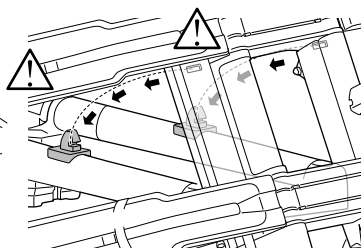

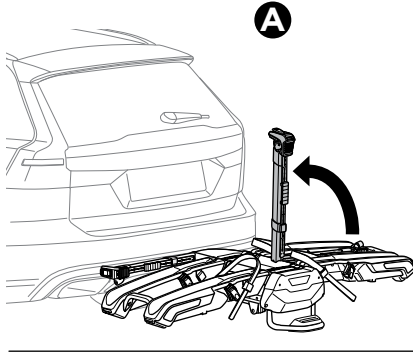

ok ✓

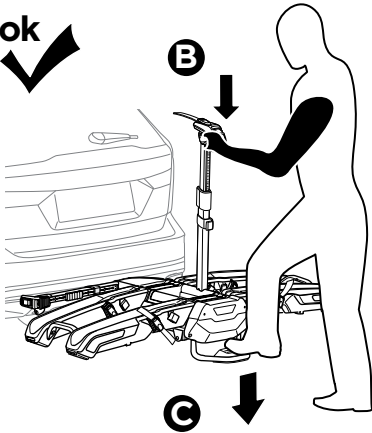

Not ok ✗

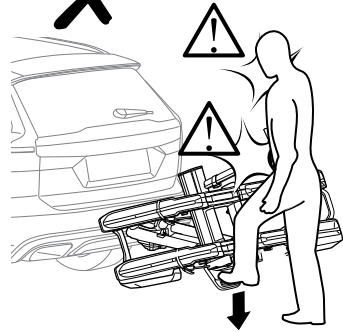

ok ✓

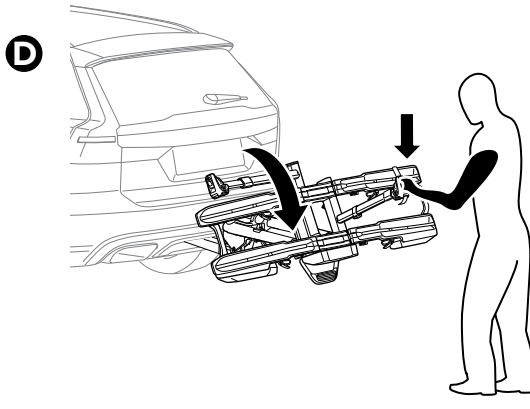



Not ok



ok

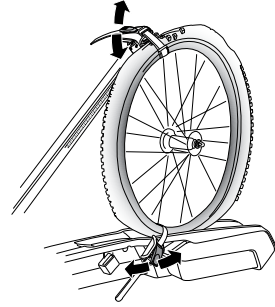

i

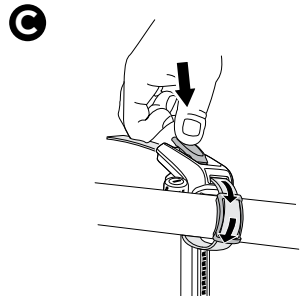
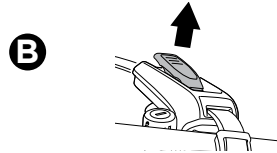
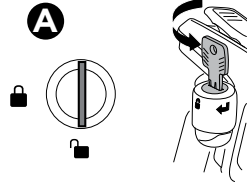
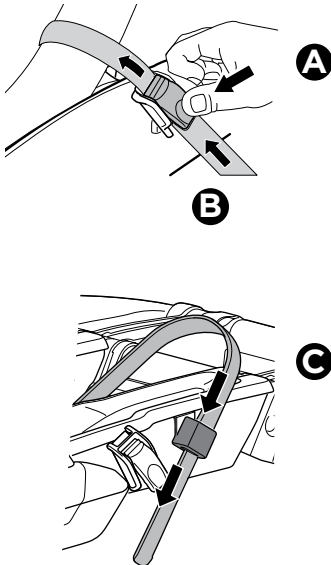
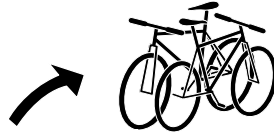

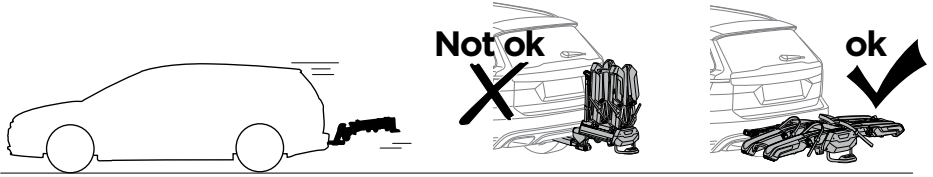

**A**

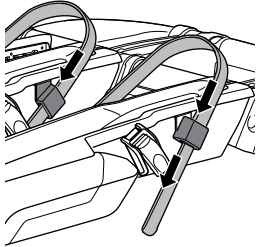

**B**

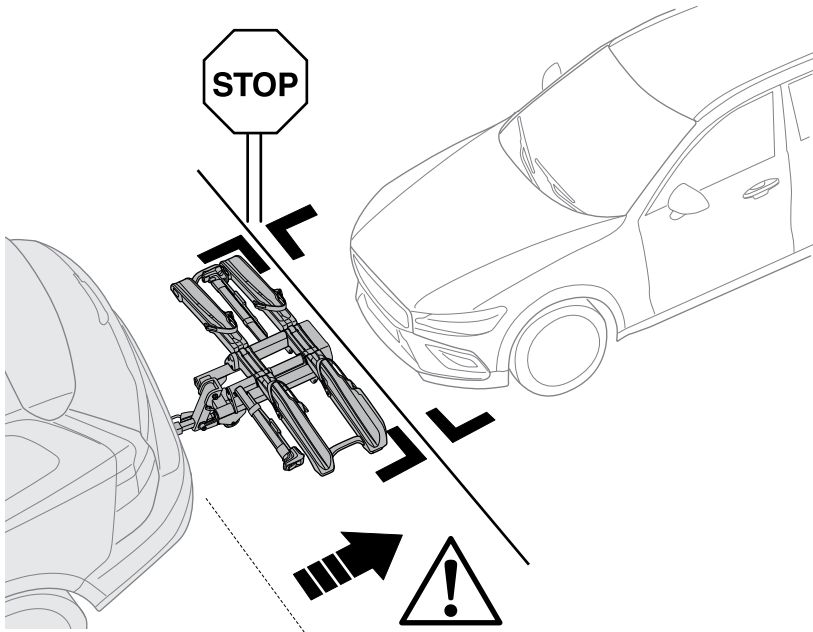
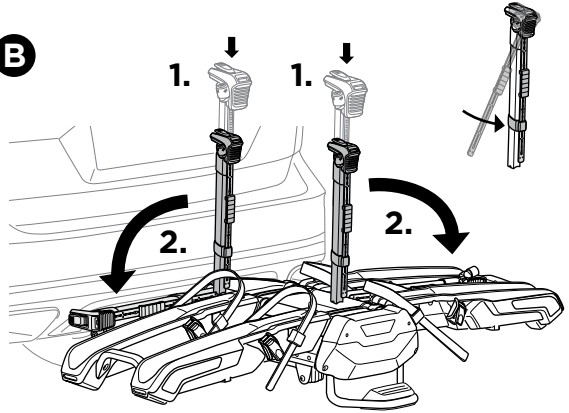

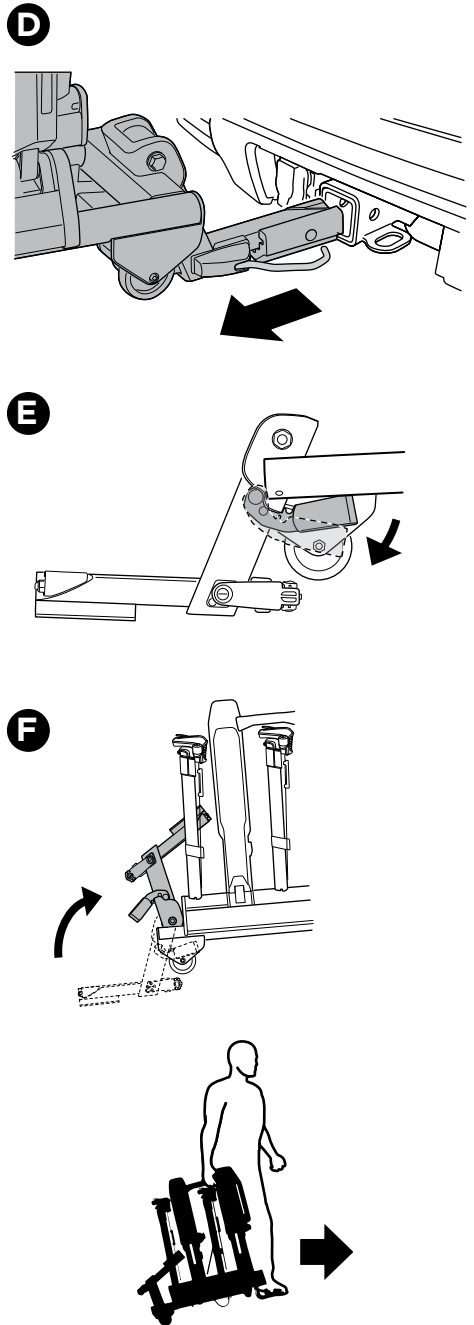
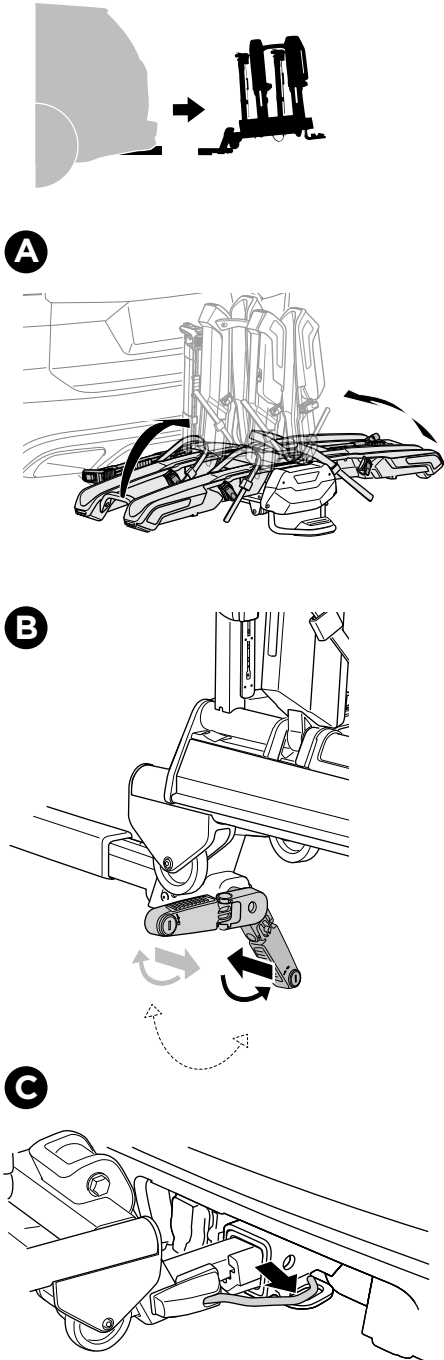



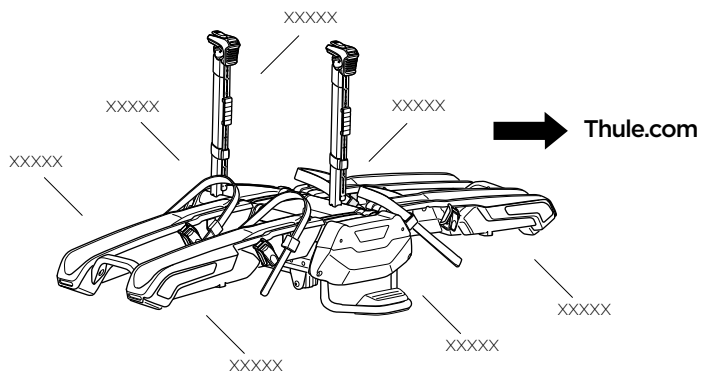

**EN** Accessoires  
**FR** Accessoires

**ES** Accesorios  
**PT** Acessórios

**Thule Epos Light & Plate Kit**  
90332

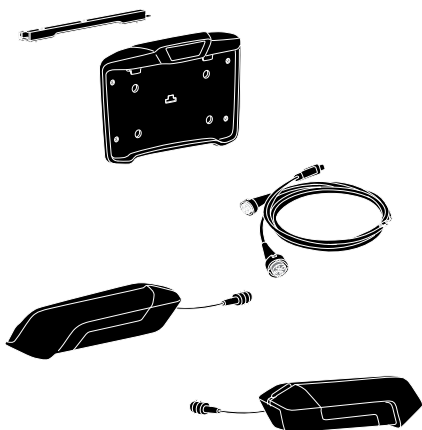

**Thule High-Grade Lock**  
9785

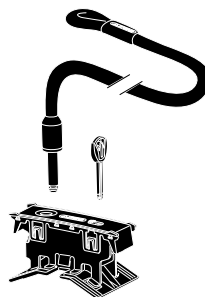

**Thule XXL Fatbike Wheel Straps**  
9851

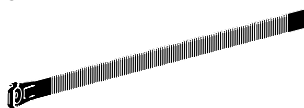

**Thule Foldable Loading Ramp**  
9334

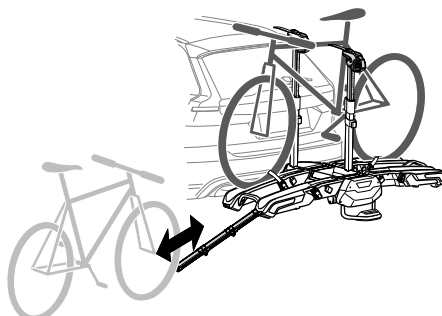
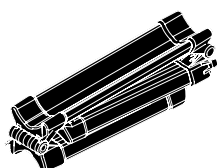

# Thule One-Key System

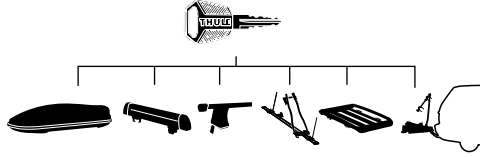

450200  (x2)

450400  (x4)

450600  (x6)

450800  (x8)

## Thule Epos 2-bike Storage Bag 9786

**A**

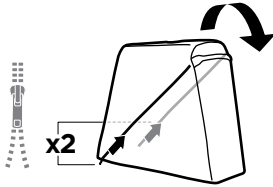

**C**

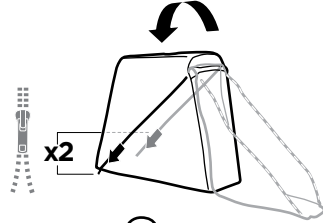

**B**

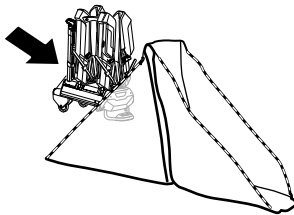

**D**



**i**

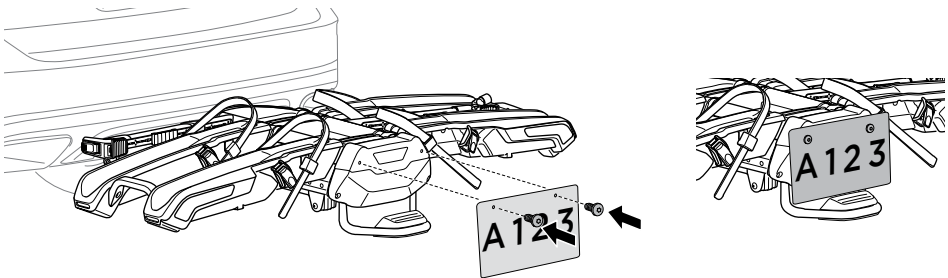

**THULE**<sup>®</sup>  
SWEDEN

Register online at  
[www.thule.com/register](http://www.thule.com/register)

Thule Inc. • 42 Silvermine Road • Seymour, CT 06483  
Thule Canada Inc. • 710 Bernard • Granby QC J2J 0H6  
North American Consumer Service: Toll Free 800-238-2388 / Fax 450-777-3615 • [www.thule.com](http://www.thule.com)