

1

Kit 145227

SUZUKI Ertiga, 5-dr MPV, 19-

TOYOTA Rumion, 5-dr MPV, 19-



ISO 11154-E

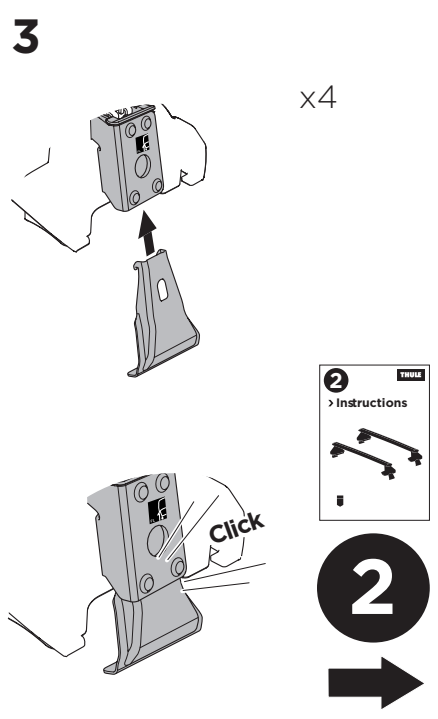
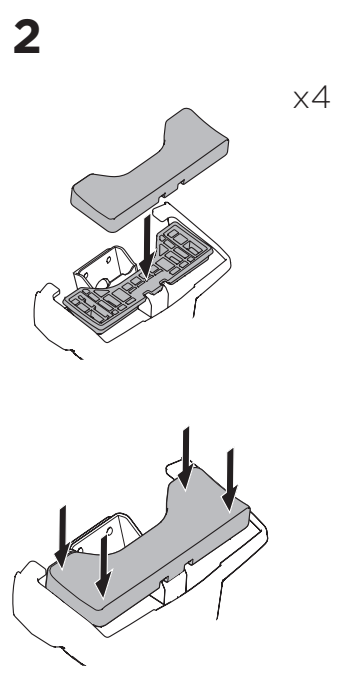
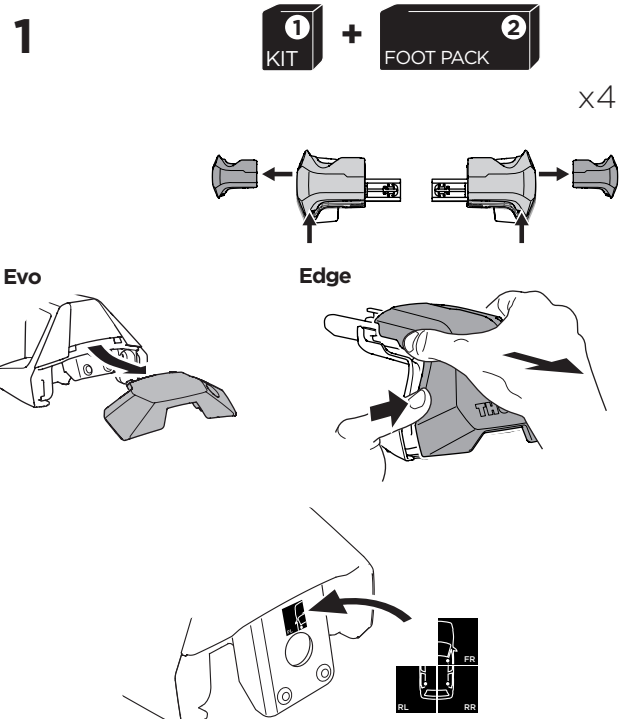
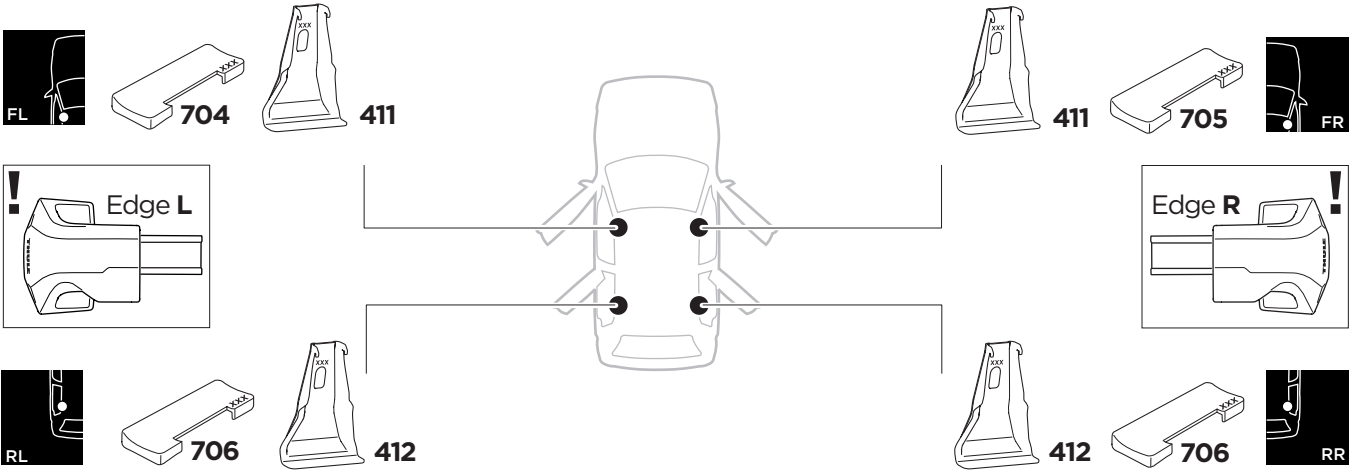
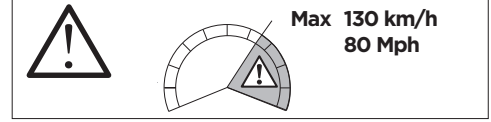
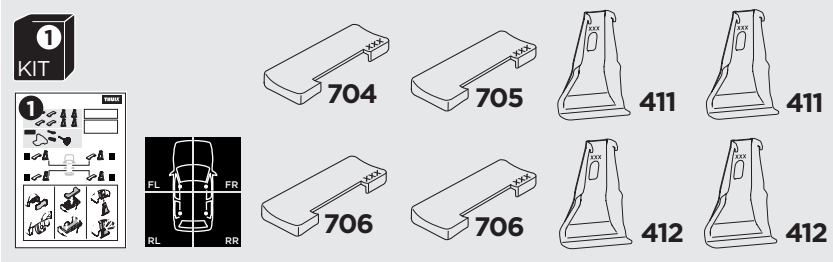



THULE WingBar Evo	THULE WingBar Edge	THULE WingBar	THULE SquareBar Evo	Evo X (scale)	Edge X (scale)
SUZUKI Ertiga, 5-dr MPV, 19-				44,5	H
TOYOTA Rumion, 5-dr MPV, 19-				44,5	H

THULE ProBar Evo	THULE SlideBar Evo			X (mm/inch)	
SUZUKI Ertiga, 5-dr MPV, 19-				1096 mm / 43 1/8"	
TOYOTA Rumion, 5-dr MPV, 19-				1096 mm / 43 1/8"	

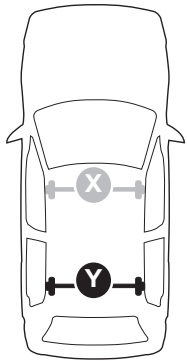

THULE WingBar Evo	THULE WingBar Edge	THULE WingBar	THULE SquareBar Evo	Evo Y (scale)	Edge Y (scale)
SUZUKI Ertiga, 5-dr MPV, 19-				37,0	E
TOYOTA Rumion, 5-dr MPV, 19-				37,0	E

THULE ProBar Evo	THULE SlideBar Evo			Y (mm/inch)	
SUZUKI Ertiga, 5-dr MPV, 19-				1021 mm / 40 1/4"	
TOYOTA Rumion, 5-dr MPV, 19-				1021 mm / 40 1/4"	

	W (mm/inch)	Z (mm/inch)
SUZUKI Ertiga, 5-dr MPV, 19-	700 mm / 27 1/2"	610 mm / 24"
TOYOTA Rumion, 5-dr MPV, 19-	700 mm / 27 1/2"	610 mm / 24"

