

➤ Instructions

Thule Approach Awning 901851, 901853



➤ **Video Instructions**
Thule Approach Awning



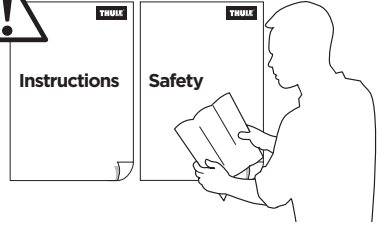
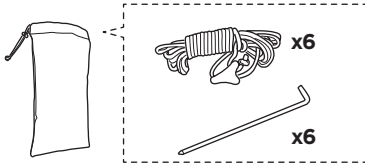
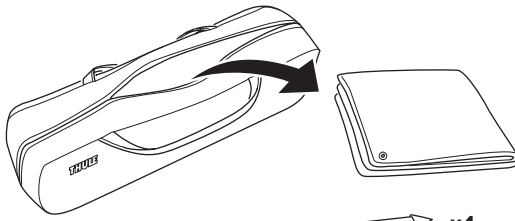

i

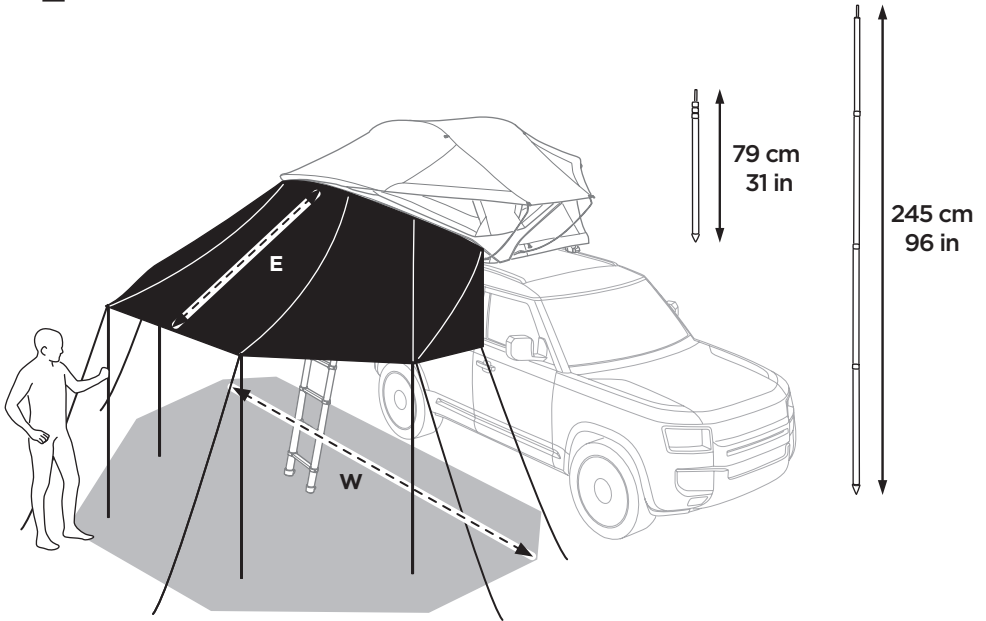

	Weight	Dimensions Open E x W
S/M Thule Approach Awning S/M 901851	4 kg 9 lbs	210 x 400 cm 83 x 160 in
L Thule Approach Awning L 901853	4.1 kg 9 lbs	210 x 400 cm 83 x 160 in

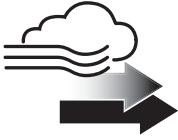

1

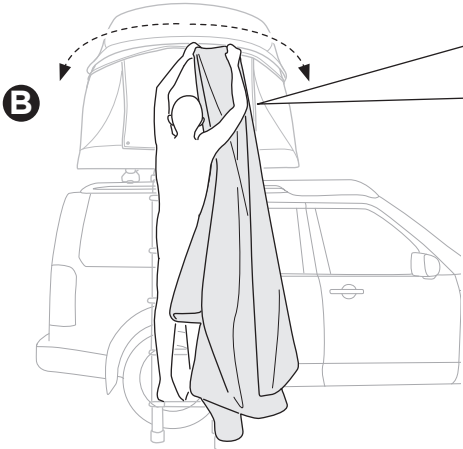

A

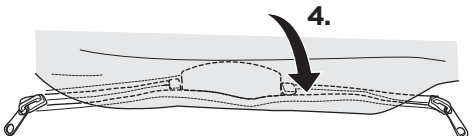
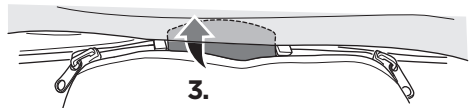
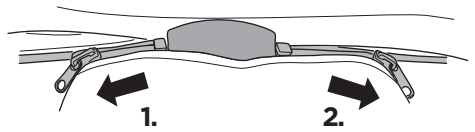

2

A

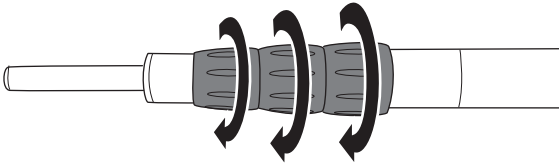

B

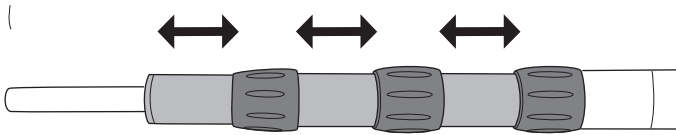

C

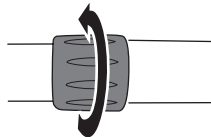

3

A

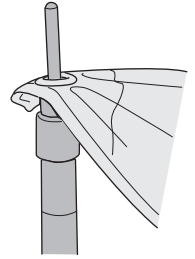
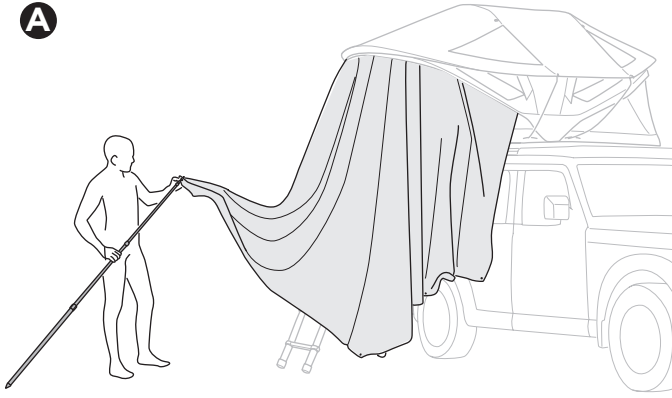

B

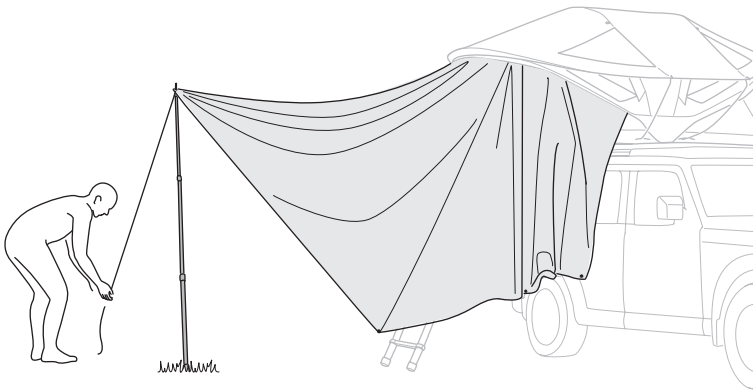

C

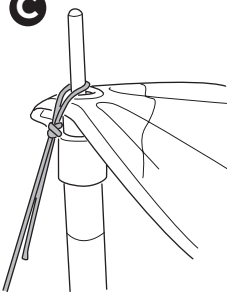

D

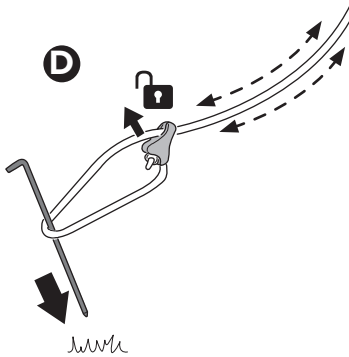

E

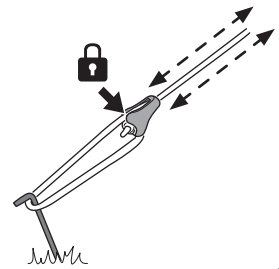

x4

4

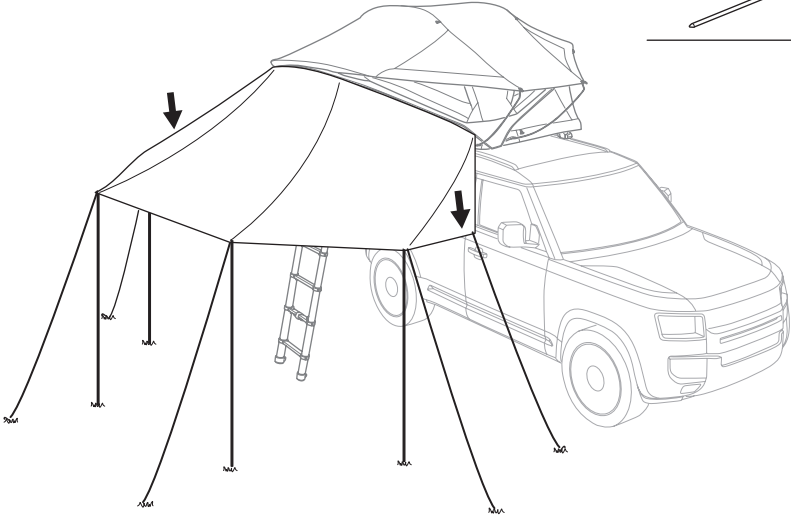
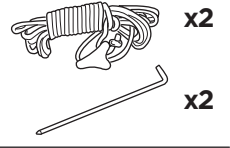

A

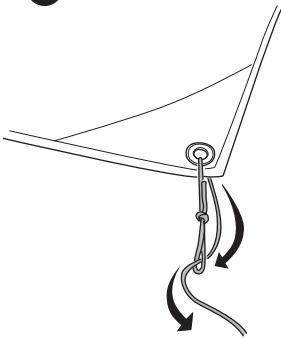

B

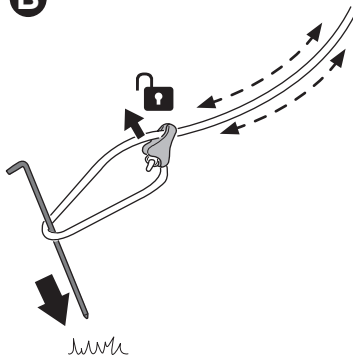

C

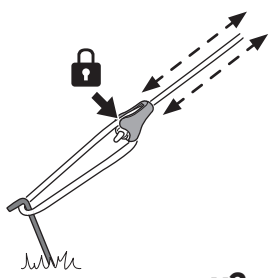

x2

i



A

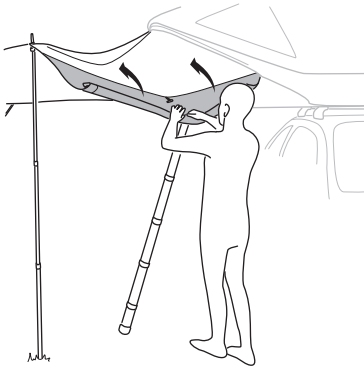

B

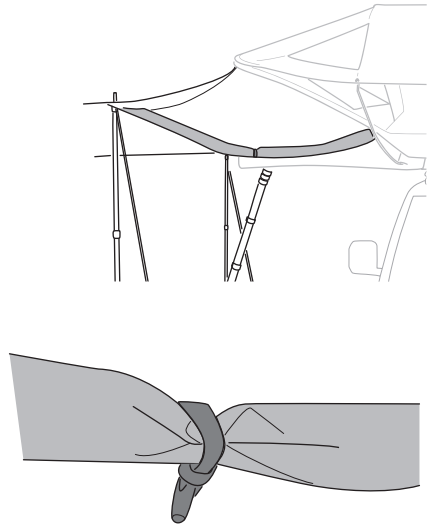

i

