

# 1

## Kit 145271



FORD F-150, 4-dr Pickup, 21-  
 FORD F-150 Lightning, 4-dr Pickup, 22-  
 FORD F-150, 4-dr Pickup, 15-20  
 FORD Super Duty, 4-dr Pickup, 17-



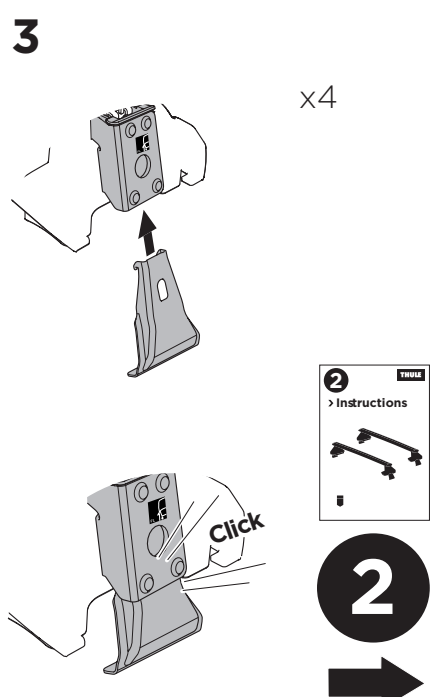
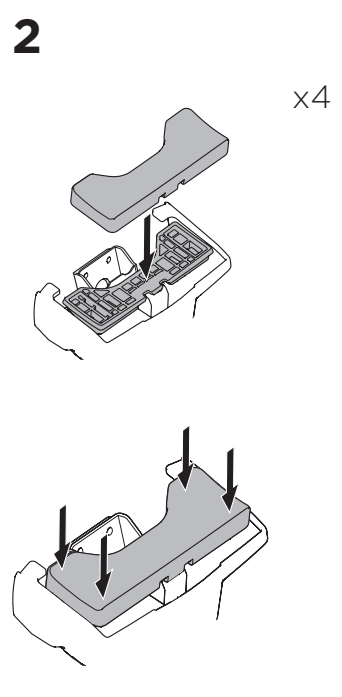
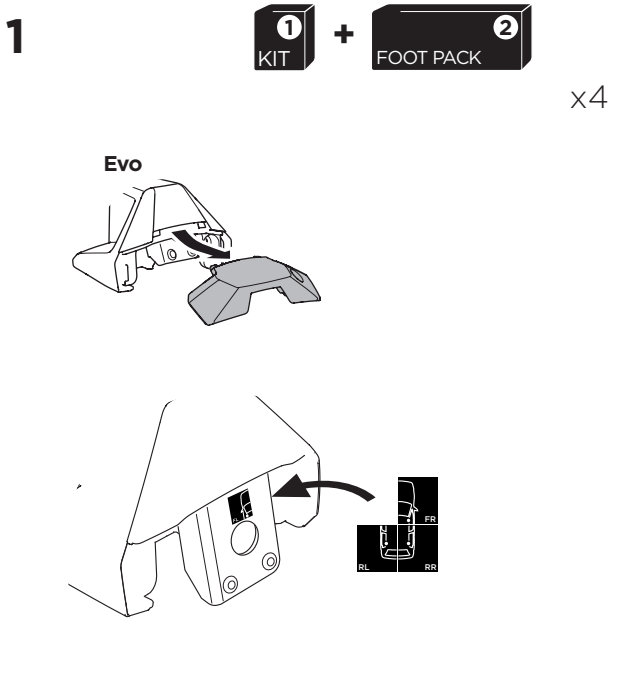
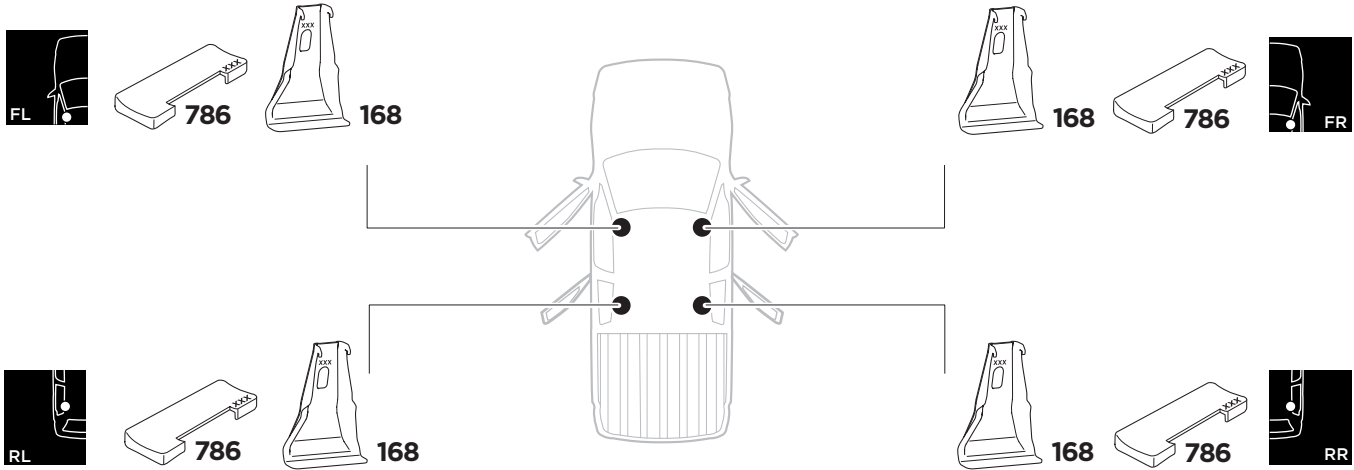
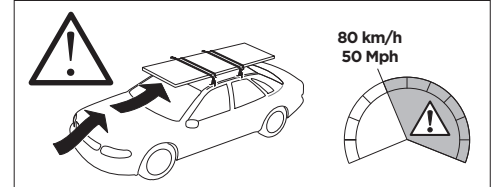
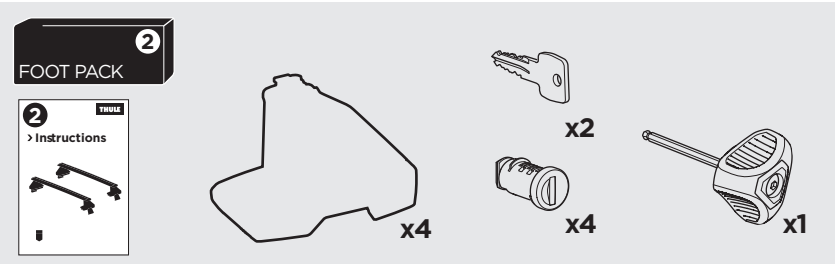
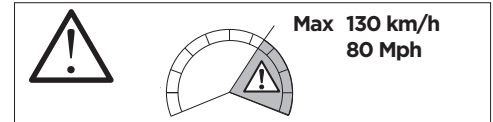
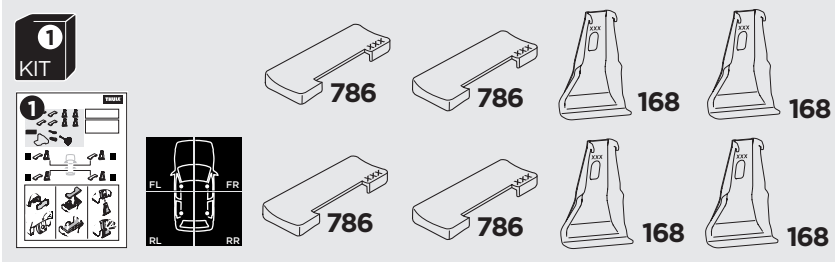

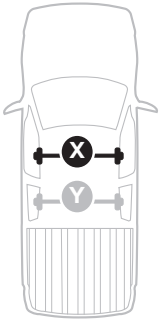
ISO 11154-E



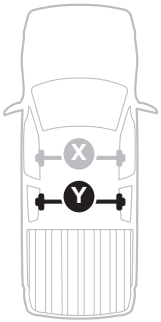

 THULE ProBar Evo  THULE SlideBar Evo	X (mm/inch)
<b>FORD F-150</b> , 4-dr Pickup, 21-	1321 mm / 52"
<b>FORD F-150 Lightning</b> , 4-dr Pickup, 22-	1321 mm / 52"
<b>FORD F-150</b> , 4-dr Pickup, 15-20	1321 mm / 52"
<b>FORD Super Duty</b> , 4-dr Pickup, 17-	1326 mm / 52 1/4"



 THULE ProBar Evo  THULE SlideBar Evo	Y (mm/inch)
<b>FORD F-150</b> , 4-dr Pickup, 21-	1321 mm / 51 3/4"
<b>FORD F-150 Lightning</b> , 4-dr Pickup, 22-	1321 mm / 51 3/4"
<b>FORD F-150</b> , 4-dr Pickup, 15-20	1316 mm / 51 3/4"
<b>FORD Super Duty</b> , 4-dr Pickup, 17-	1321 mm / 52"

	W (mm/inch)	Z (mm/inch)
<b>FORD F-150</b> , 4-dr Pickup, 21-	700 mm / 27 1/2"	340 mm / 13 3/8"
<b>FORD F-150 Lightning</b> , 4-dr Pickup, 22-	700 mm / 27 1/2"	340 mm / 13 3/8"
<b>FORD F-150</b> , 4-dr Pickup, 15-20	700 mm / 27 1/2"	340 mm / 13 3/8"
<b>FORD Super Duty</b> , 4-dr Pickup, 17-	700 mm / 27 1/2"	340 mm / 13 3/8"

