

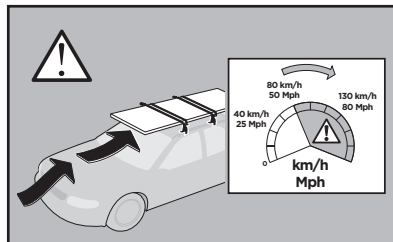

Thule Rapid System Kit 1815

> Instructions

MINI Clubman, 5-dr Hatchback, 16-

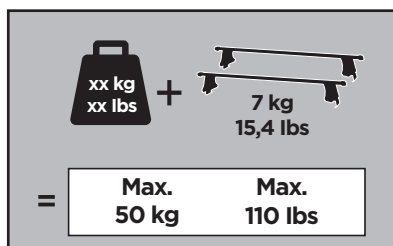

ISO 11154-E

141815
C.20180202
519-1815-02

Bring your life
thule.com



182 x4

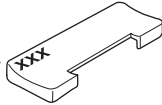

1372 x4



52576

x2

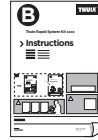

x1



x1

1

	X (scale)	X (mm)	X (inch)
MINI Clubman, 5-dr Hatchback, 16-	31.5	966	38

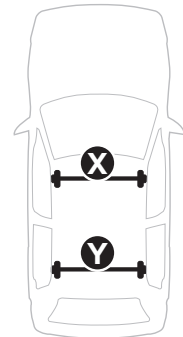
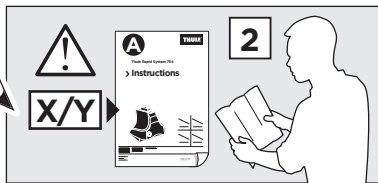
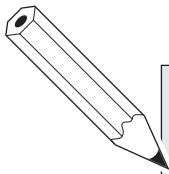

	Y (scale)	Y (mm)	Y (inch)
MINI Clubman, 5-dr Hatchback, 16-	30.5	956	37 ⁵ / ₈

2

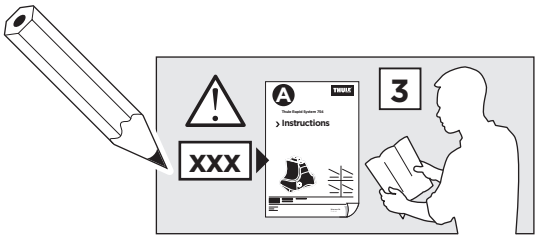
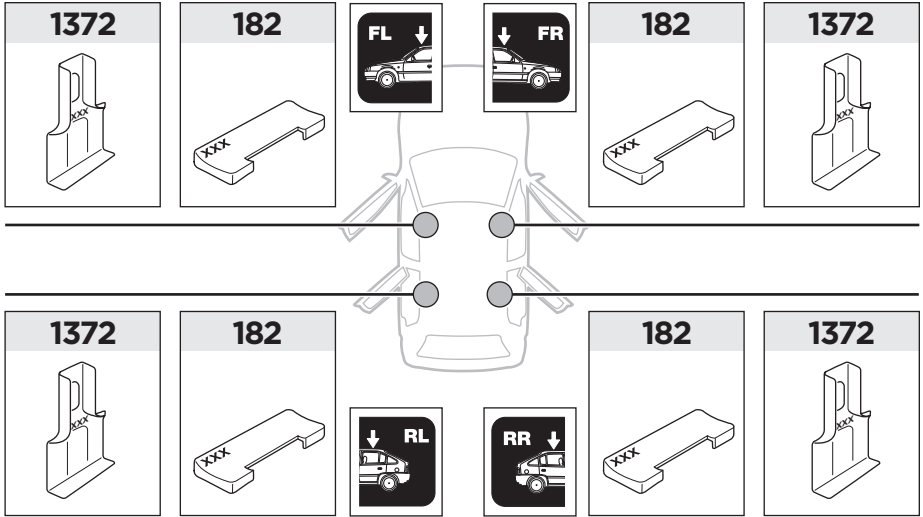

3

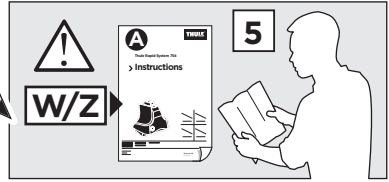

	W (mm)	Z (mm)	W (inch)	Z (inch)
MINI Clubman , 5-dr Hatchback, 16-	385	745	15 1/8	29 3/8

