

Thule Rapid System Kit 1684

> Instructions

CHEVROLET Malibu, 4-dr Sedan, 13-16

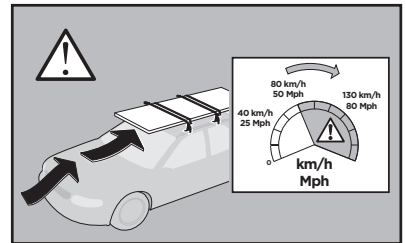
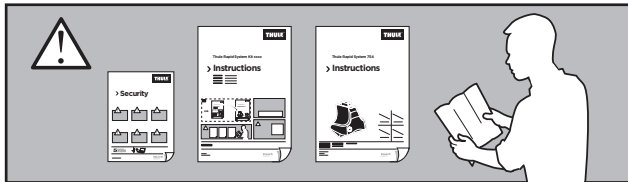
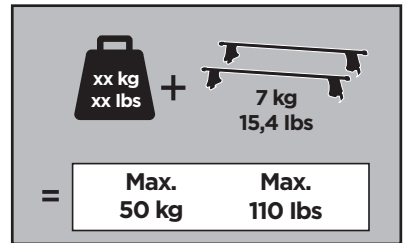
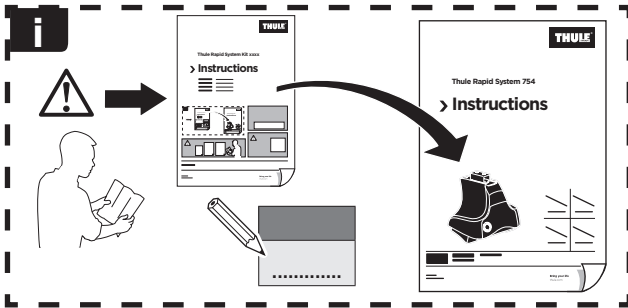

ISO 11154-E



368 x1



369 x1

393 x1

394 x1



544 x2



1192 x2



x1

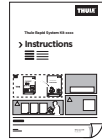

x1

1

	X (scale)	X (mm)	X (inch)
CHEVROLET Malibu, 4-dr Sedan, 13-16	40	1051	41 ³/₈

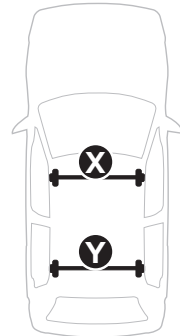
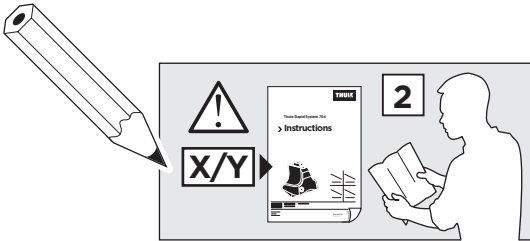

	Y (scale)	Y (mm)	Y (inch)
CHEVROLET Malibu, 4-dr Sedan, 13-16	41	1061	41 ³/₄

2

CHEVROLET Malibu, 4-dr Sedan, 13-16

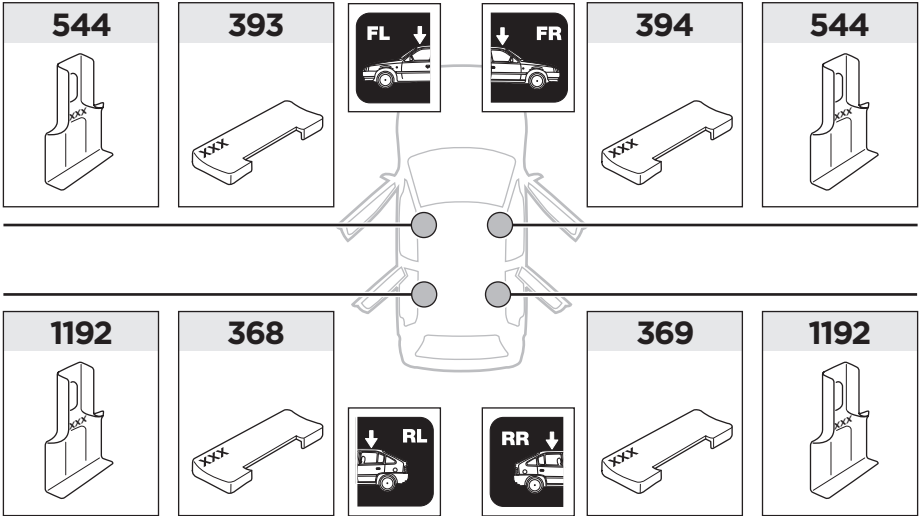

3

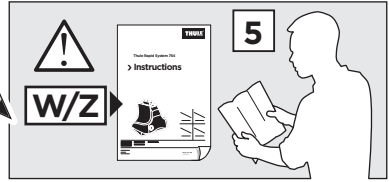

	W (mm)	Z (mm)	W (inch)	Z (inch)
CHEVROLET Malibu, 4-dr Sedan, 13-16	240	650	9 1/2	25 5/8

