

➤ Instructions

Thule RideAlong Lite 2 100209, 100210, 100211

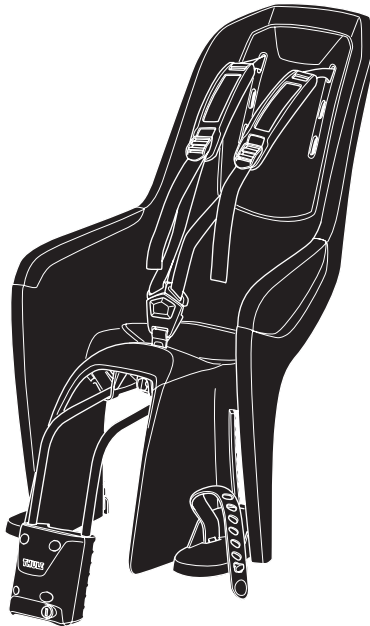

EN Rear mounted child bike seat
FR Siège vélo enfant arrière
ES Asiento para niños en la parte trasera de la bicicleta
DE Fahrradkindersitz
NL Fietszitje voor achterop
PT Assento infantil traseiro para bicicleta
IT Seggiolino da bicicletta posteriore
SV Cykelbarnstol för bakre cykelmontering
DK Bagmonteret cykelstol
NO Bakmontert barnesykkelse
FI Lastenistuin polkupyörän taakse
IS Barnasæti aftan á reiðhjól
ET Jalgratta tagumine lasteiste
LV Velosipēda aizmugurējais bērna sēdekļis
LT Galinė vaikiška dviračio kėdutė
RU Заднее детское велосипедное сиденье
UK Заднє дитяче велосипедне крісло
PL Fotelik rowerowy do przewożenia dziecka montowany z tyłu

CS Zadní dětská cyklosedačka
HU Kerékpáros hátsó gyerekülés
RO Scaun spate de copii pentru bicicletă
SK Zadná detská cyklosedačka
SL Zadnji otroški kolesarski sedež
BG Задна детска седалка за велосипед
HR Dječja sjedalica za bicikl koja se postavlja straga
EL Πίσω παιδικό κάθισμα ποδηλάτου
TR Arkaya Bağlanan Çocuk Bisiklet Koltuğu
MT Sedil tar-Rota għat-Tfal li Jitpoġġa Wara

מושב אופניים אחורי לילד **HE**
 مقعد الدراجة الخلفي للطفل **AR**

ZH (CN) 后座式儿童自行车座椅
ZH (TW) 後座式自行車兒童座椅
JA サイクル後部用チャイルドシート
KO 후면 어린이 자전거 시트
TH เก้าอี้เด็กสำหรับซ้อนท้ายจักรยาน
MS Tempat Duduk Basikal Kanak-kanak Belakang

EN 14344:2022

ASTM F1625-00

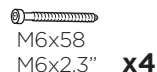
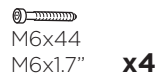
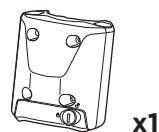
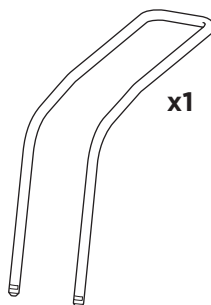
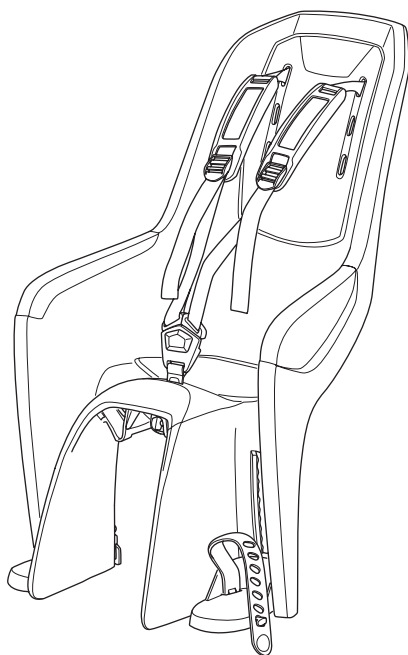

- EN** Please read the following instructions carefully and keep them for future reference.
- DE** Bitte die folgenden Anleitung aufmerksam durch und bewahren Sie sie zum späteren Nachschlagen auf.
- FR** Veuillez lire attentivement les instructions suivantes et les conserver pour référence future.
- NL** Dient u zorgvuldig de volgende instructies te lezen en deze als toekomstig naslagwerk te bewaren.
- IT** Leggi le seguenti istruzioni attentamente e conservale per consultazioni future.
- ES** Lea las instrucciones siguientes atentamente y guárdelas para consultas posteriores.
- PT** Leia cuidadosamente as instruções a seguir e guarde-as para referência futura.
- SV** Vi ber dig läsa följande instruktioner noggrant och därefter behålla dem för framtida bruk.
- DK** Skål du læse følgende anvisninger grundigt igennem og gemme dem til fremtidig reference.
- NO** Bør du lese disse instruksjonene nøye. Ta vare på dem i tilfelle du får bruk for dem senere.
- FI** Lue seuraavat ohjeet huolellisesti. Pidä ohjeet tallessa.
- IS** Lestu þessar leiðbeiningar vandlega áður en þú og geymdu þær til síðari nota.
- ET** kasutuselevõttu lugege järgmised juhised hoolikalt läbi ja hoidke need alles.
- LV** lūdzu, izlasiet uzmanīgi tālāk sniegtos norādījumus un saglabājiet tos turpmākai izmantošanai.
- LT** atidžiai perskaitykite toliau pateiktas instrukcijas ir jų neišmeskite, kad galėtumėte peržiūrėti ateityje.
- PL** należy dokładnie przeczytać następujące instrukcje i zachować je do wykorzystania w przyszłości.
- RU** внимательно изучите представленные ниже инструкции и сохраните их для дальнейшего использования.
- UK** ознайомтеся з нижченаведеними інструкціями й зберігайте їх для довідки в майбутньому.
- BG** прочетете внимателно следните инструкции и ги запазете за бъдещи справки.
- CS** si pečlivě přečtěte následující pokyny a uložte si je, abyste se k nim mohli kdykoli vrátit.
- SK** si pozorne prečítajte nasledujúce pokyny a uložte si ich, aby ste sa k nim mohli kedykoľvek vrátiť.
- SL** skrbno preberite navodila v nadaljevanju in jih shranite.
- HR** pažljivo pročitajte sljedeće upute i sačuvajte ih za buduću uporabu.
- RO** citiți cu atenție următoarele instrucțiuni și păstrați-le pentru consultare ulterioară.
- HU** használatbavétele előtt figyelmesen olvassa el az alábbi tudnivalókat, és tartsa azokat később is hozzáférhető helyen
- EL** διαβάστε προσεκτικά τις παρακάτω οδηγίες και φυλάξτε τις για μελλοντική αναφορά.
- TR** kullanmadan önce aşağıdaki talimatları dikkatle okuyun ve gelecekte başvurmak amacıyla saklayın.
- MT** jekk jogħġbok aqra l-istruzzjonijiet li ġejjin bir-reqqa u żommmhom għal referenza futura.
- HE** קרא את ההוראות להלן בקפידה ושמור עליהן לעיון במועד מאוחר יותר.
- AR** يرجى قراءة التعليمات التالية بعناية والاحتفاظ بها للرجوع إليها في المستقبل.
- ZH (CN)** 请仔细阅读以下说明,并保留该说明以供日后参考。
- ZH (TW)** 請詳閱以下說明,並妥善保管以便未來參考使用。
- JA** をご利用になる前に、以下の手順を最後までお読みいただき、今後も参照できるように保管してください。
- KO** 을 사용하기 전에 다음 지침을 잘 읽고 나중에 참고할 수 있도록 보관해 주십시오.
- TH** โปรดอ่านคำแนะนำต่อไปนี้อย่างละเอียดและเก็บไว้เพื่อใช้อ้างอิงในอนาคต
- MS** sila baca arahan berikut dengan teliti dan simpan arahan ini untuk rujukan masa hadapan.

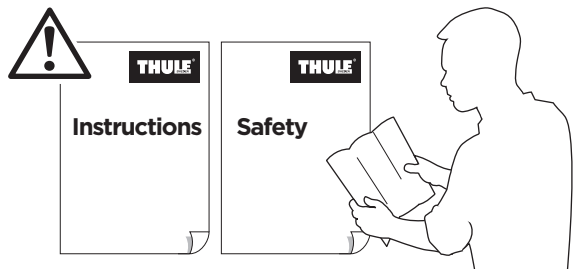



9-72 M	9-72 M
9-22 kg	20-40 lbs
110 cm	43.3 inch



i



Your Key-Number



0-9 M



Check your bike : A.2

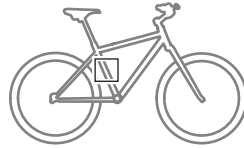

FIT

Circular



Ø 28-40 mm
Ø 1,10-1,57"

Oval



Max 40 mm
Max 1,57"



NO FIT

Triangular



Square

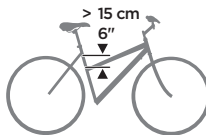

> 15 cm
6"



< 15 cm
6"

Ok



No ok

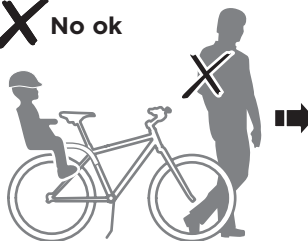



Max. 25 km/h
15 mph

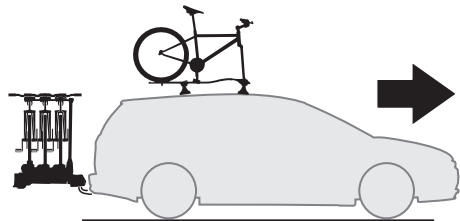
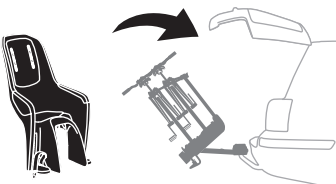
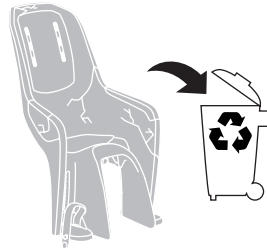
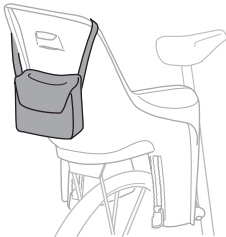
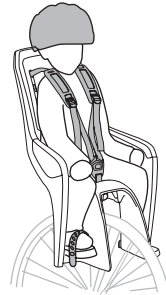
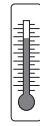
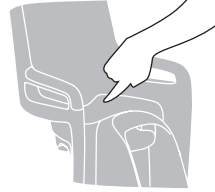
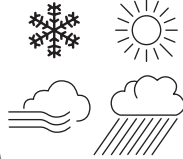
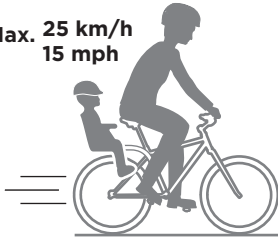

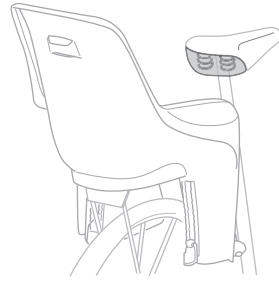
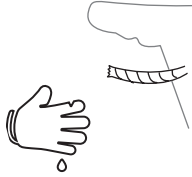
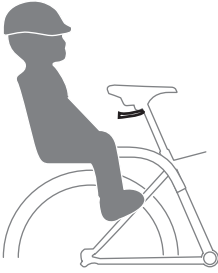
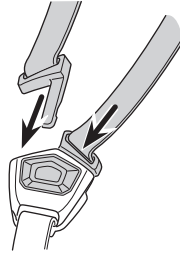
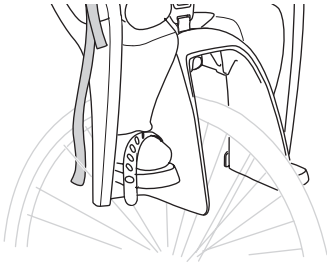



1

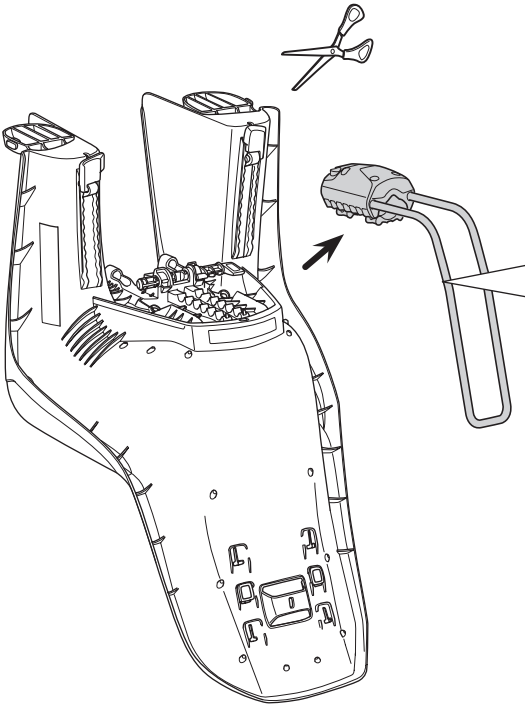

A

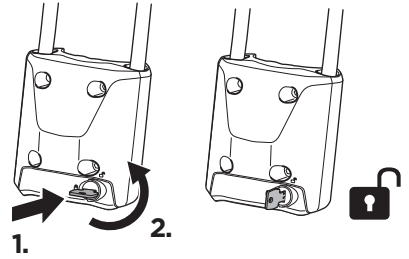

B

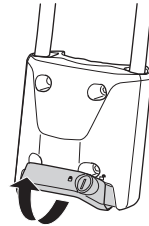

C

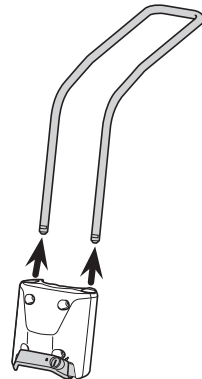

2

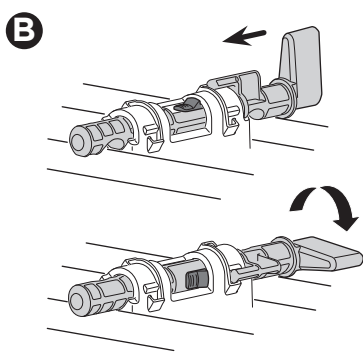
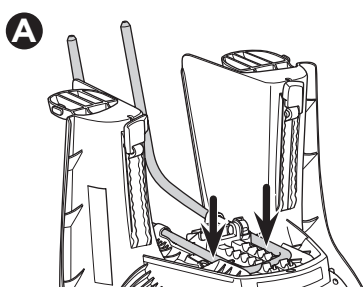
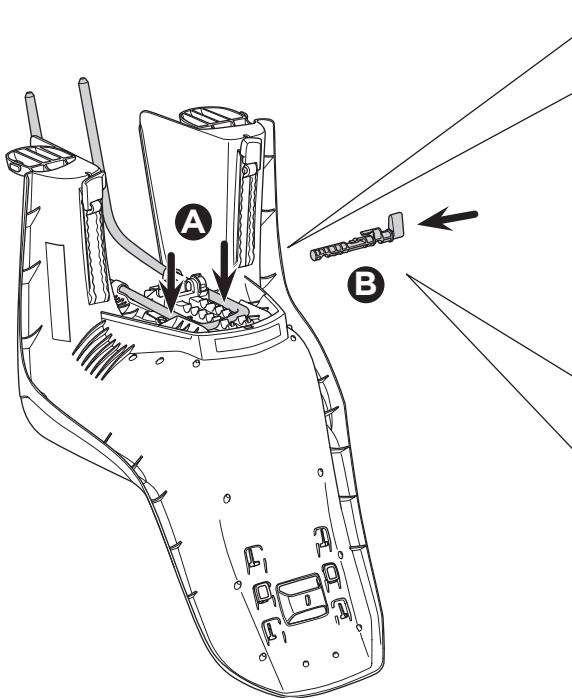
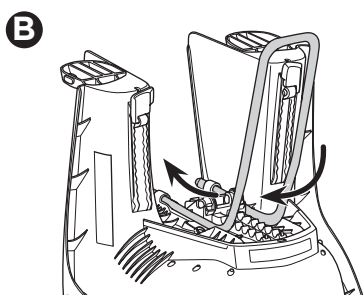
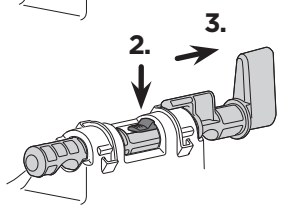
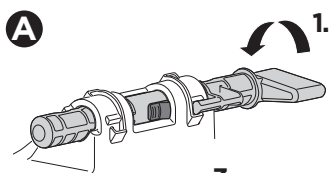
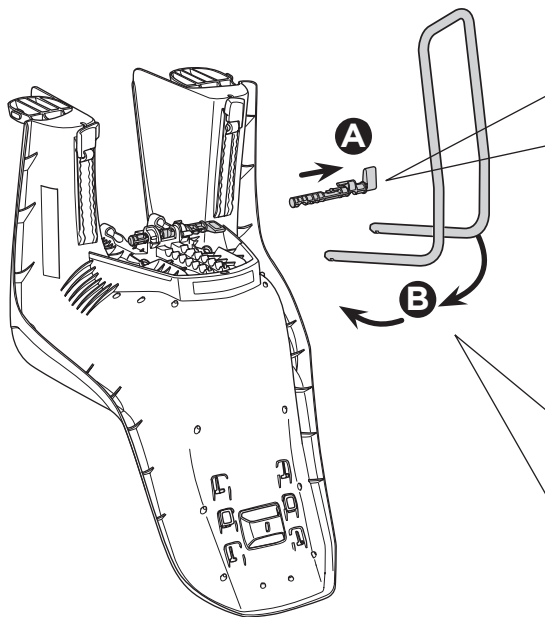



3

Ø 28-40 mm
Ø 1.10-1.57 inch

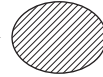
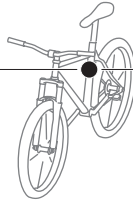
40x55 mm
1.57-2.16 inch





M6x44
M6x1.7 inch

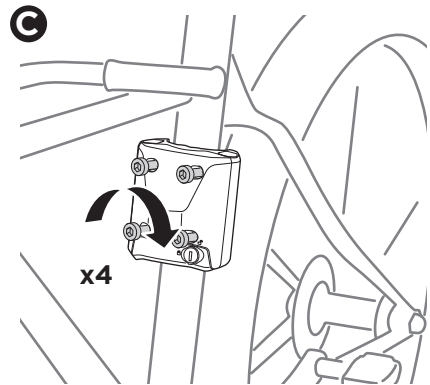
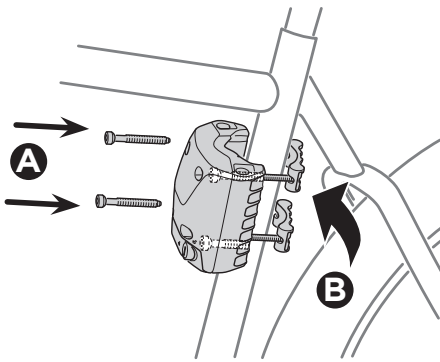

M6x58
M6x2.3 inch

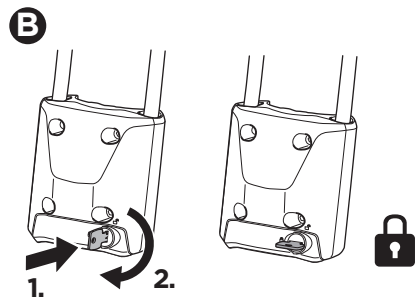
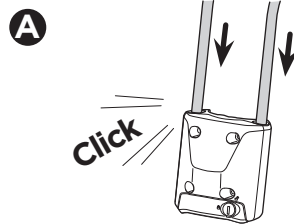
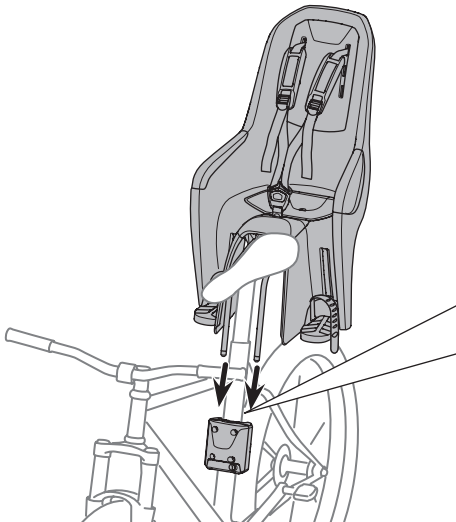

4

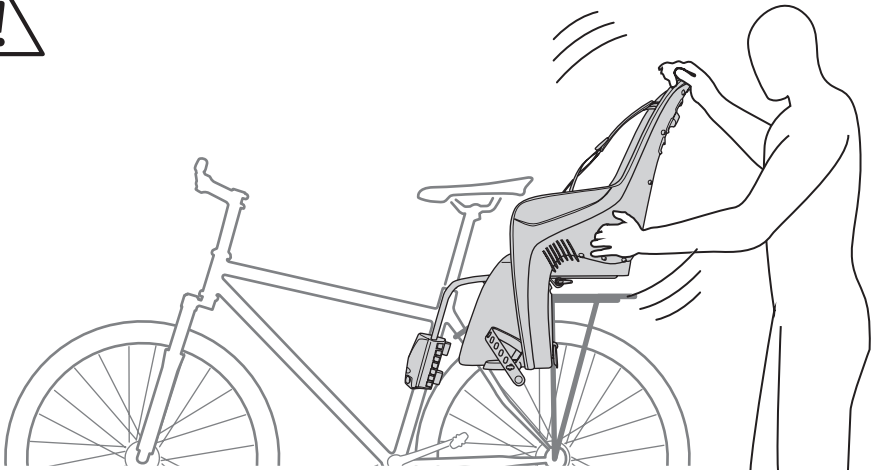
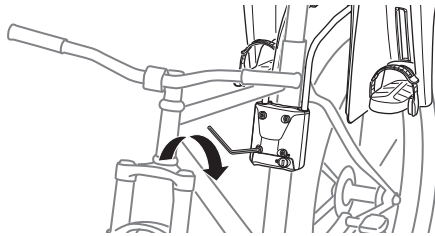
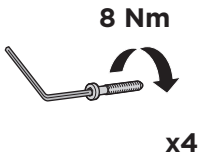
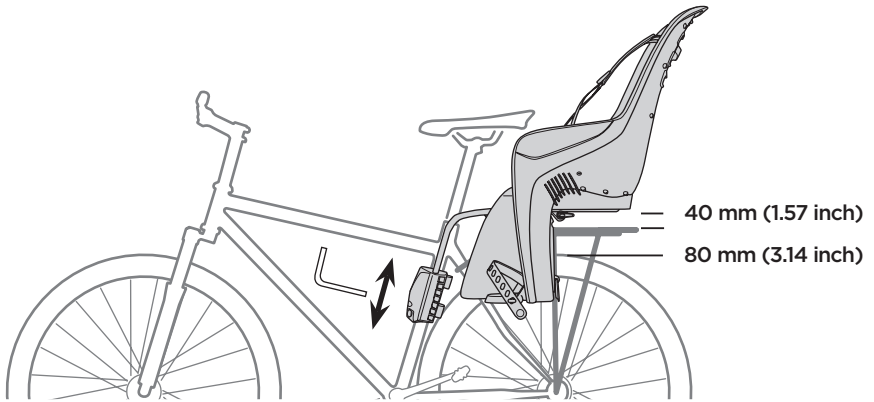

5



6

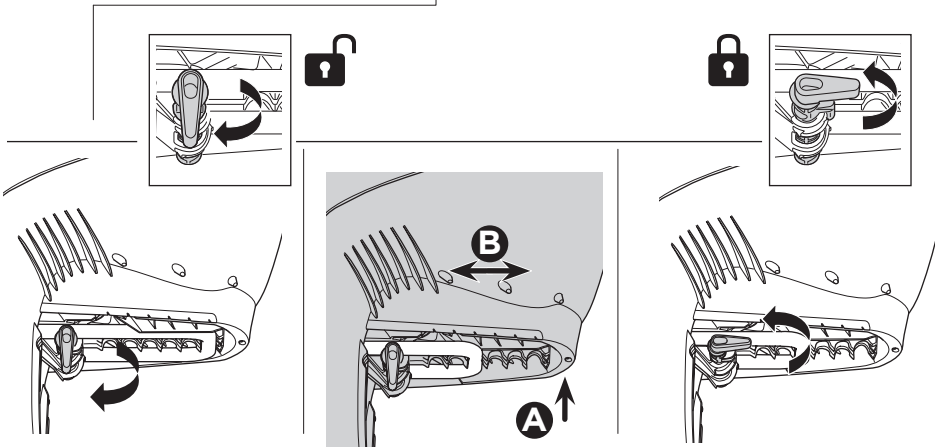
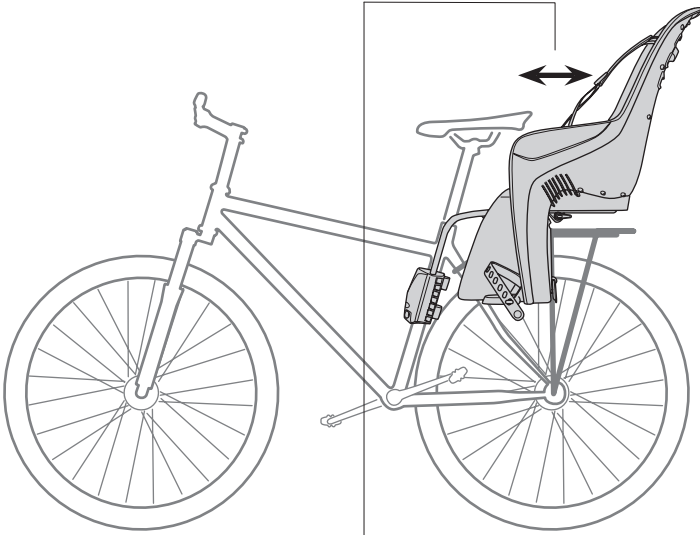
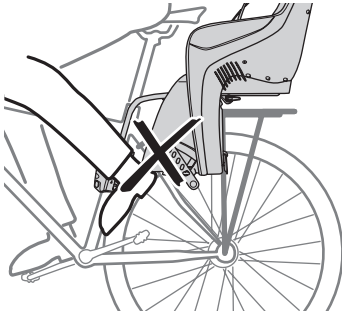



1

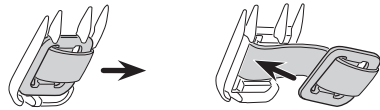
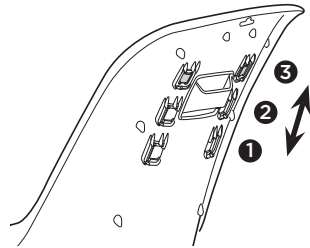
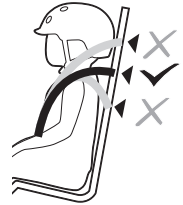
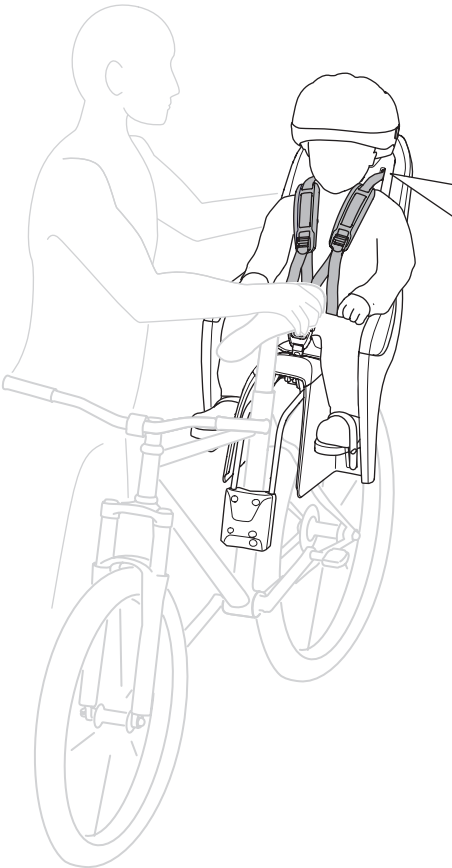
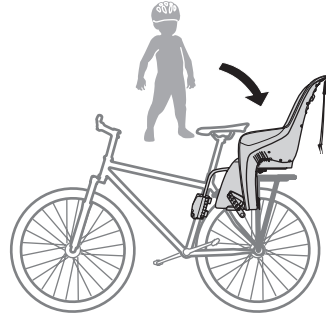
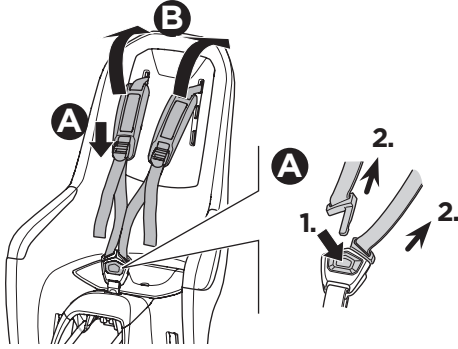

2

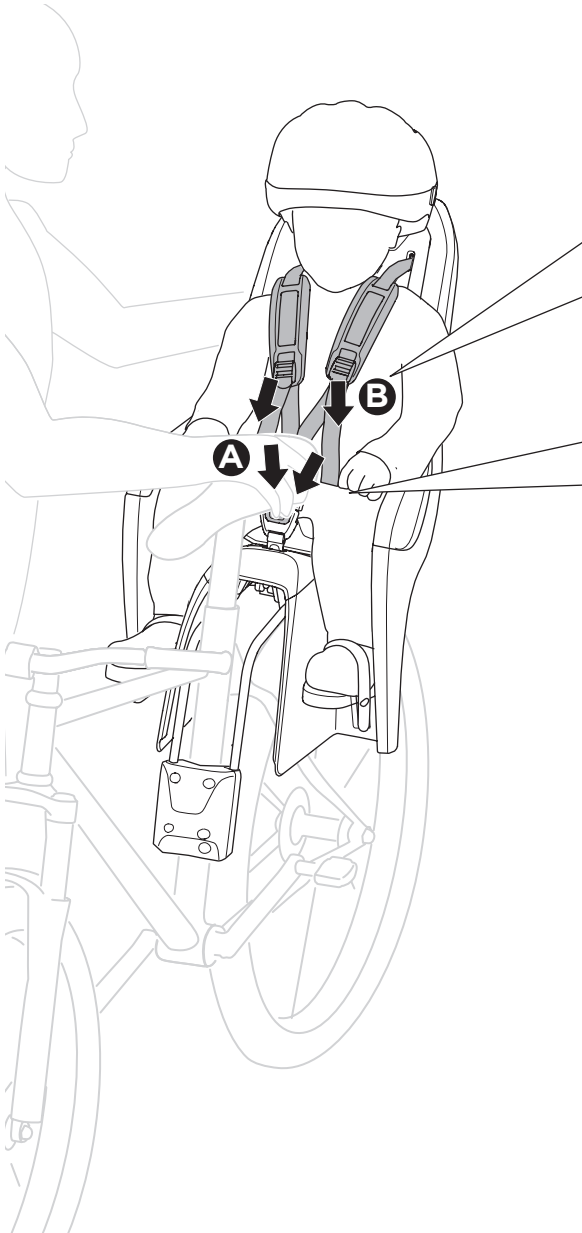

A

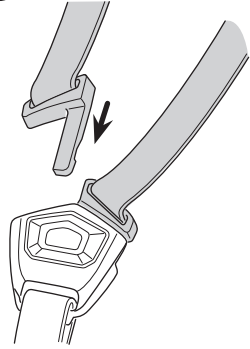

B

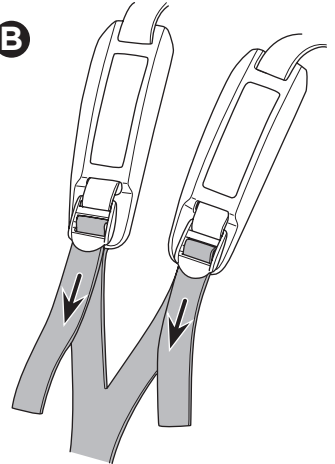

i

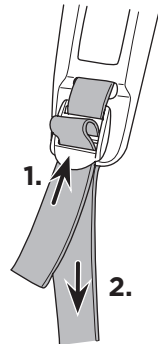

3

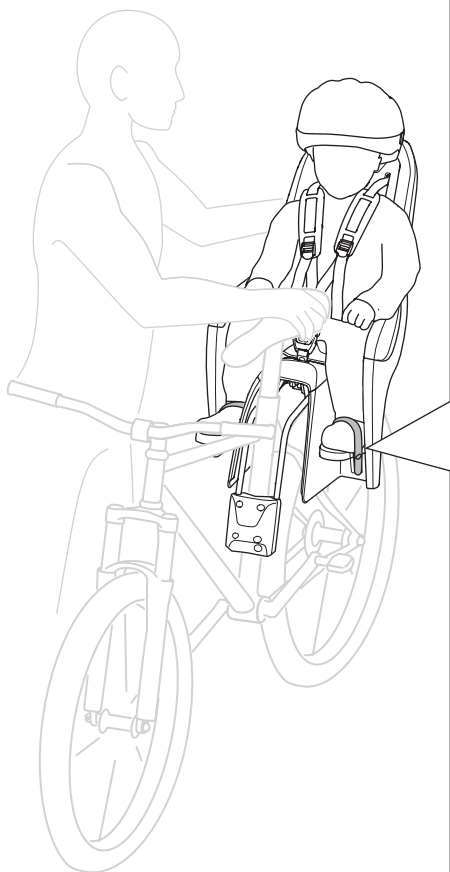

A

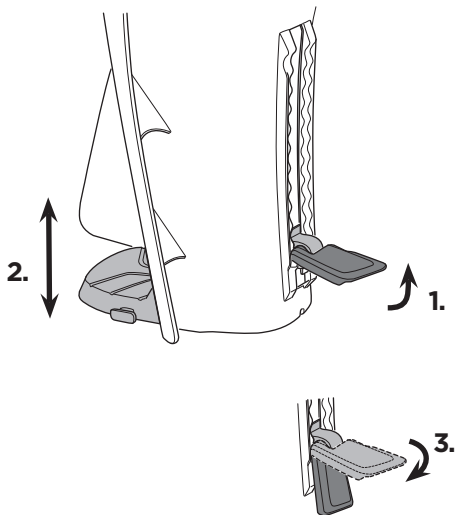

B

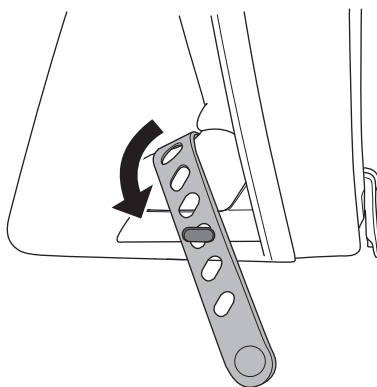

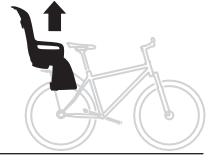

i

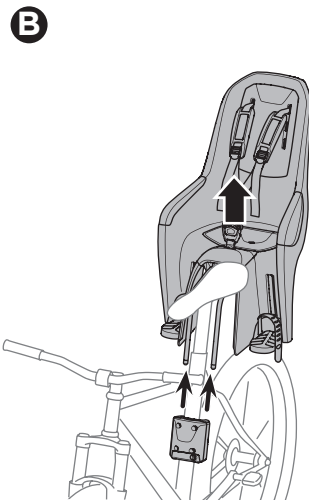
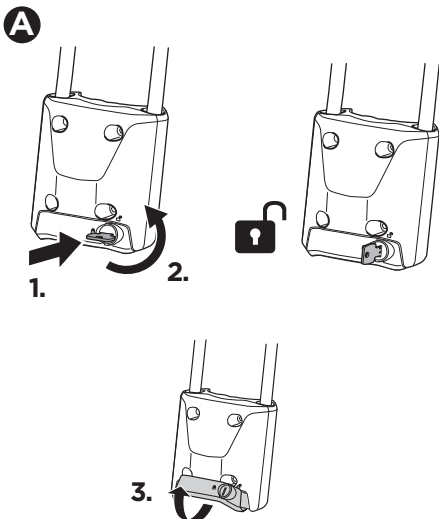
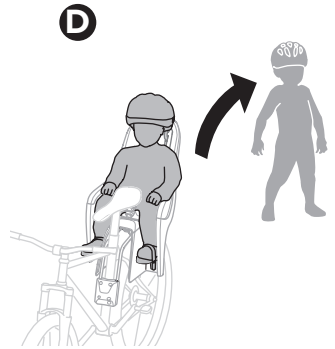
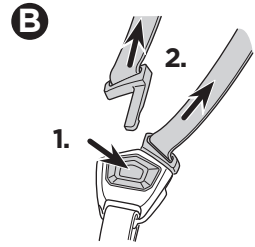
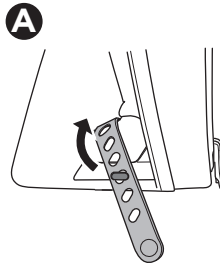

EN Accessories
 FR Accessoires
 ES Accesorios
 DE Zubehör
 NL Accessoires
 PT Acessórios
 IT Accessori
 SV Tillbehör
 DK Tilbehør
 NO Tilbehør
 FI Lisävarusteet
 IS Aukabúnaður

ET Tarvikud
 LV Piederumi
 LT Priedai
 RU Аксессуары
 UK Аксесуары
 PL Akcesoria
 CS Příslušenství
 HU Kiegészítők
 RO Accesorii
 SK Príslušenstvo
 SL Dodatna oprema
 BG Аксесоари

HR Dodatna oprema
 EL Αξεσουάρ
 TR Aksesuarlar
 MT Accessorji

אביזרים HE
 الملحقات AR

ZH (CN) 附件
 ZH (TW) 配件
 JA アクセサリー
 KO 액세서리
 TH อุปกรณ์เสริม
 MS Aksesori

Thule One-Key System

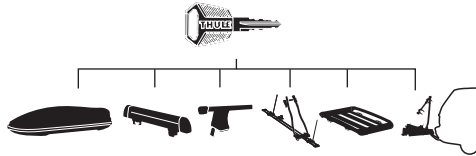

450400  (x4)

450600  (x6)

450800  (x8)

451200  (x12)

Thule Yepp Harness Clip

12020920

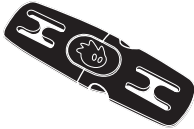

Thule Delight

20201516



Thule Quick Release Bracket

100203

