

THULE[®]
SWEDEV

➤ Instructions

Thule Approach Awning
901034, 901035



➤ **Video Instructions**
Thule Approach Awning



5564785001

Bring your life
thule.com

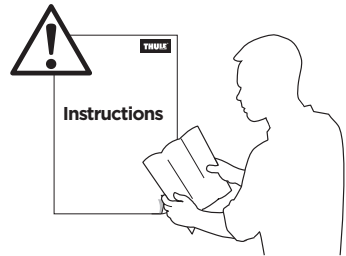
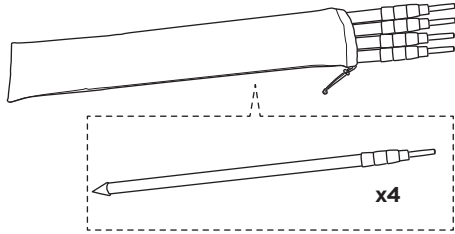
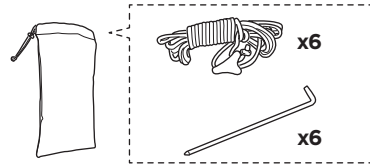
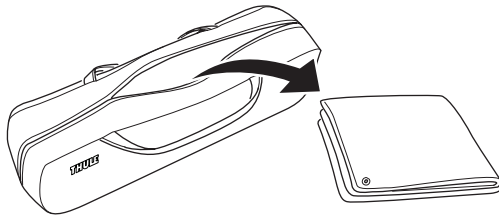

i

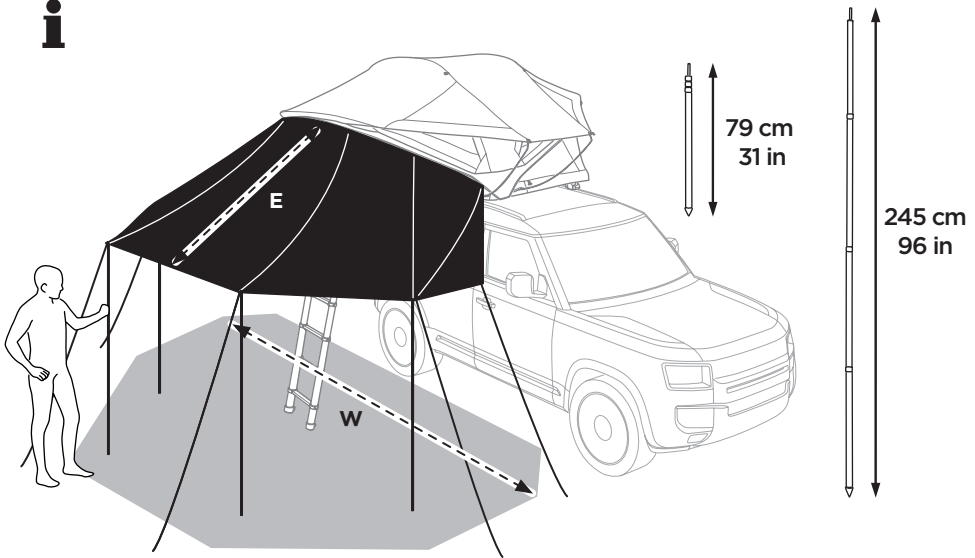

79 cm
31 in

245 cm
96 in

	Weight	Dimensions Open E x W
S/M Thule Approach Awning S/M 901034	4 kg 9 lbs	210 x 400 cm 83 x 160 in
L Thule Approach Awning L 901035	4.1 kg 9 lbs	210 x 400 cm 83 x 160 in



1

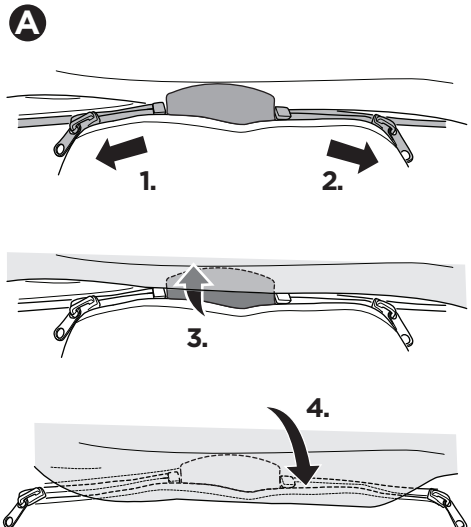
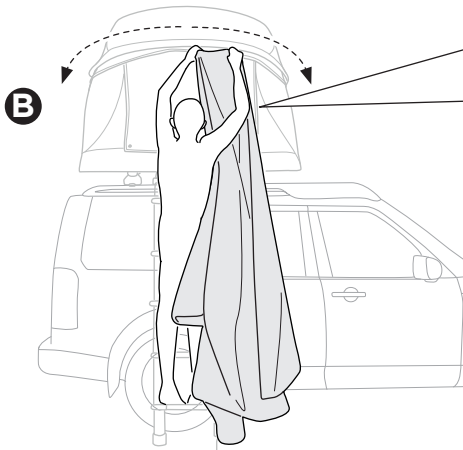
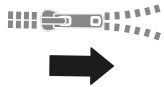

2

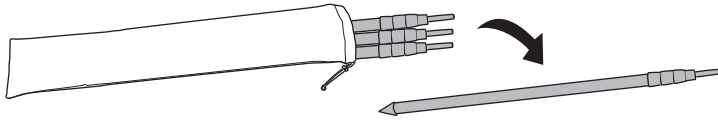

A

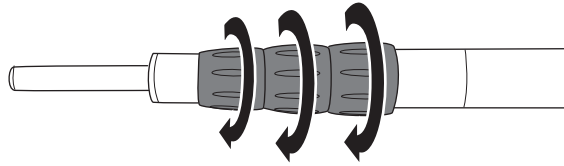

B

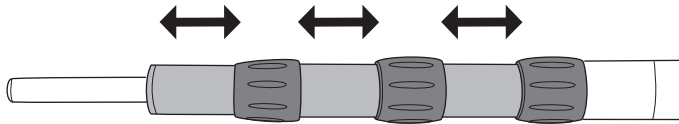

C

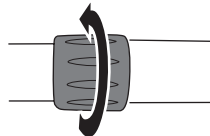
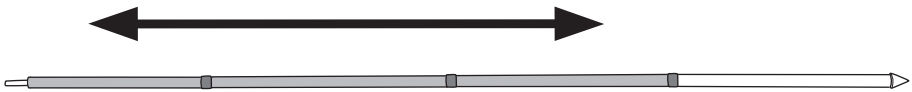

3

A

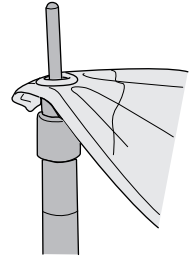
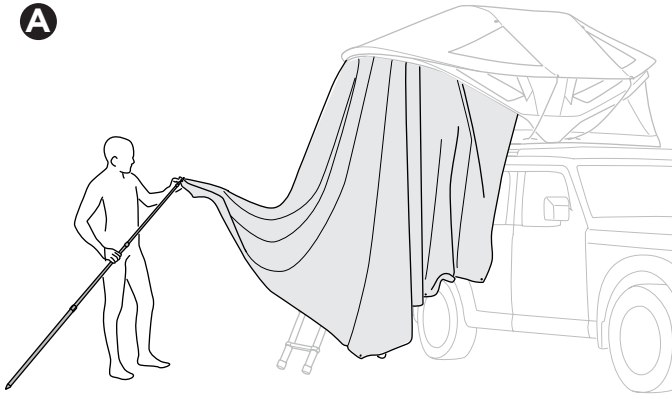

B

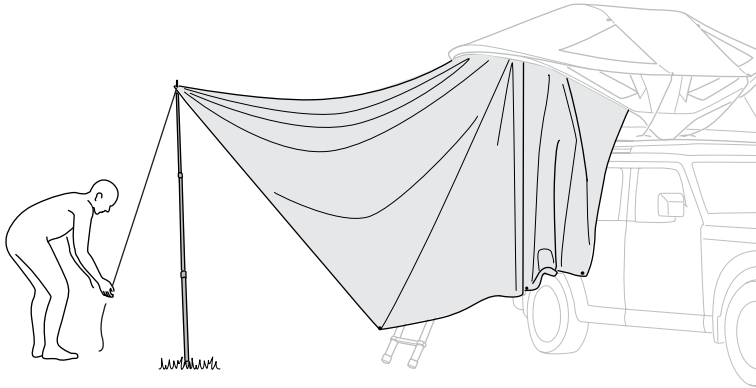

C

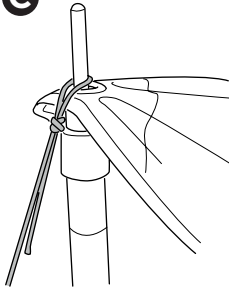

D

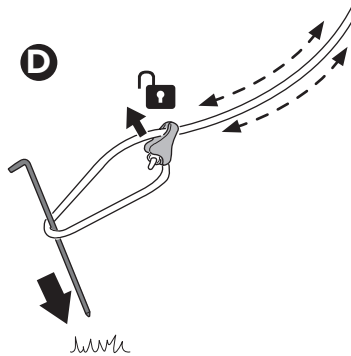

E

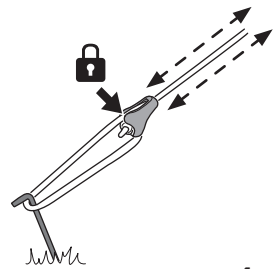

x4

4

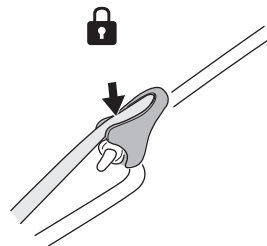
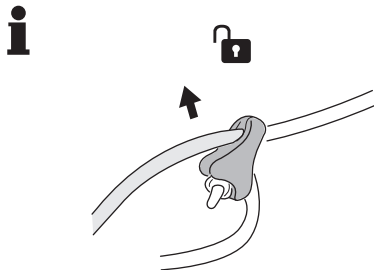
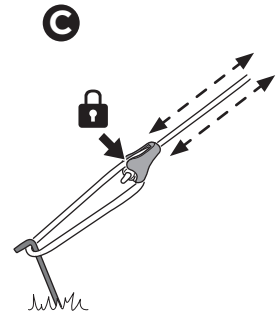
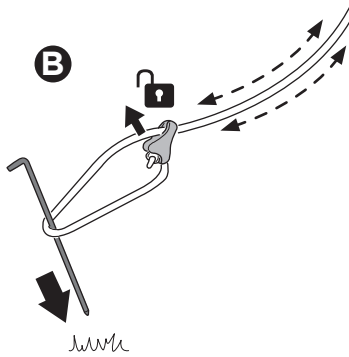
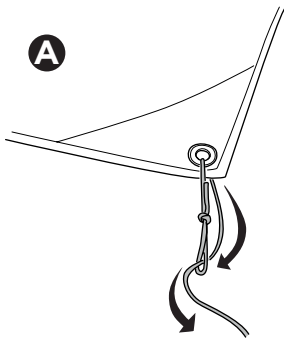
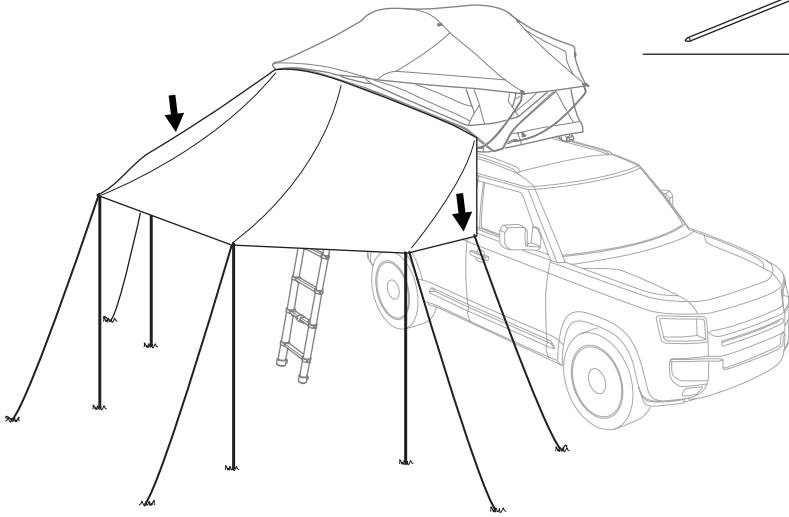

i



A

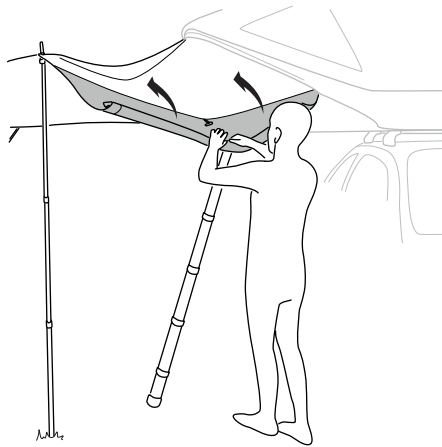

B

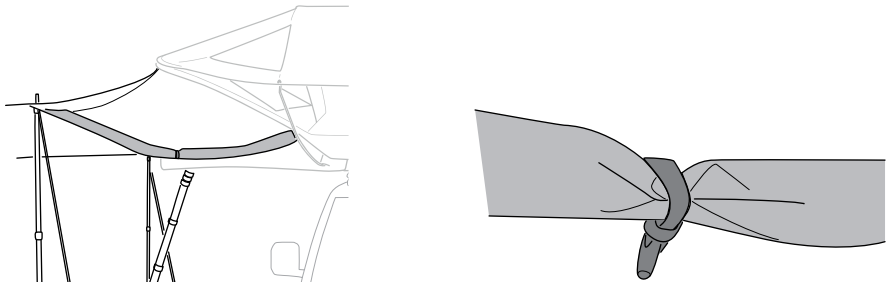

i

