

THULE[®]
SWEDEV

➤ Instructions

Thule Approach Annex
901036, 901037, 901038

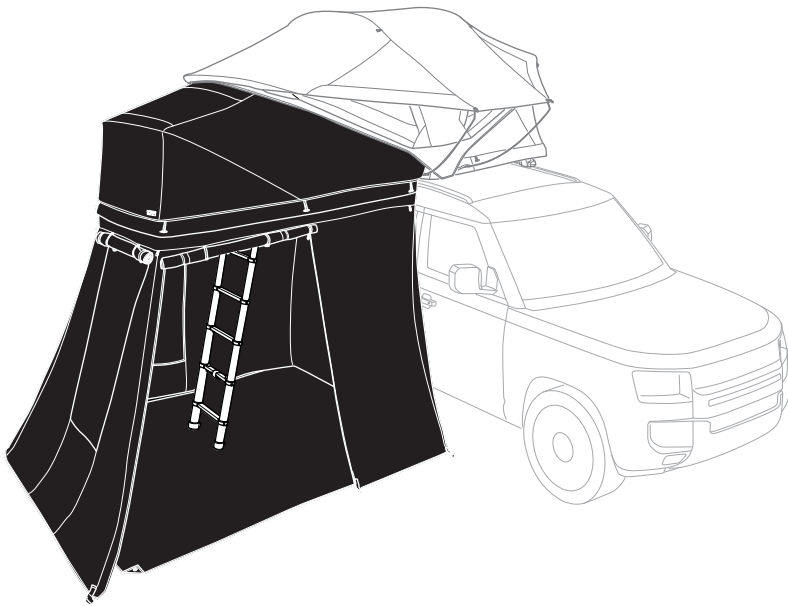

➤ **Video Instructions**
Thule Approach Annex



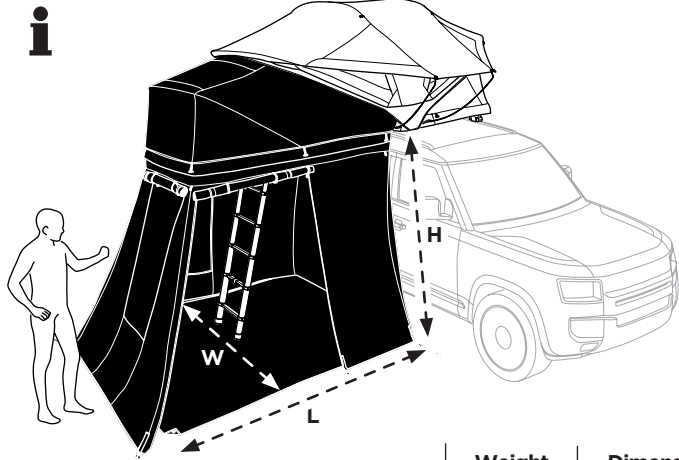
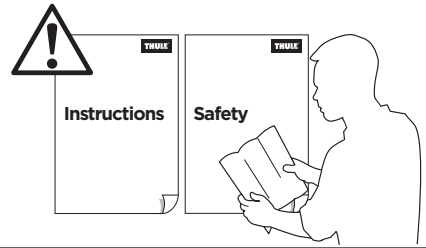
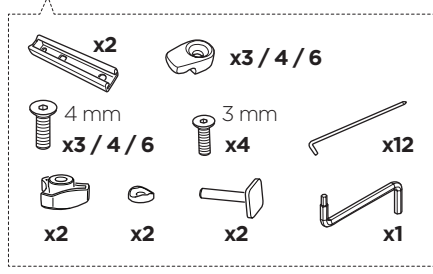
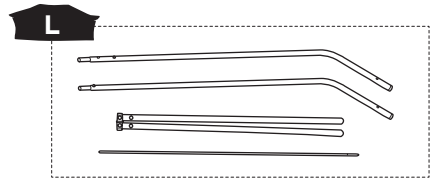
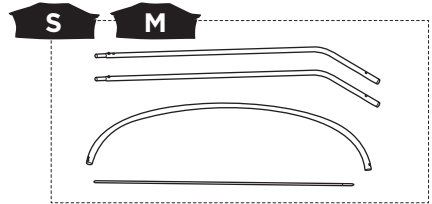
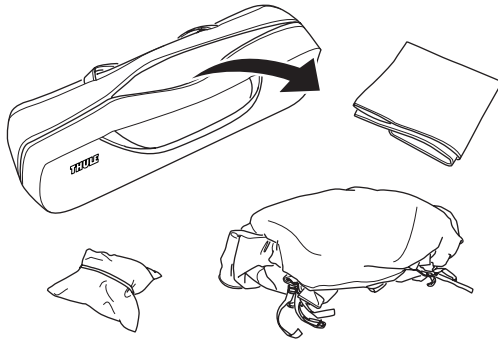

	Weight	Dimensions Floor L x W	Height
S Thule Approach Annex S 901036	6.2 kg 13.7 lbs	187 x 201 cm 74 x 79 in	165 - 215 cm 65 - 85 in
M Thule Approach Annex M 901037	7.3 kg 16.1 lbs	203 x 220 cm 80 x 87 in	165 - 215 cm 65 - 85 in
L Thule Approach Annex L 901038	7.7 kg 17 lbs	253 x 220 cm 99 x 87 in	165 - 215 cm 65 - 85 in

1

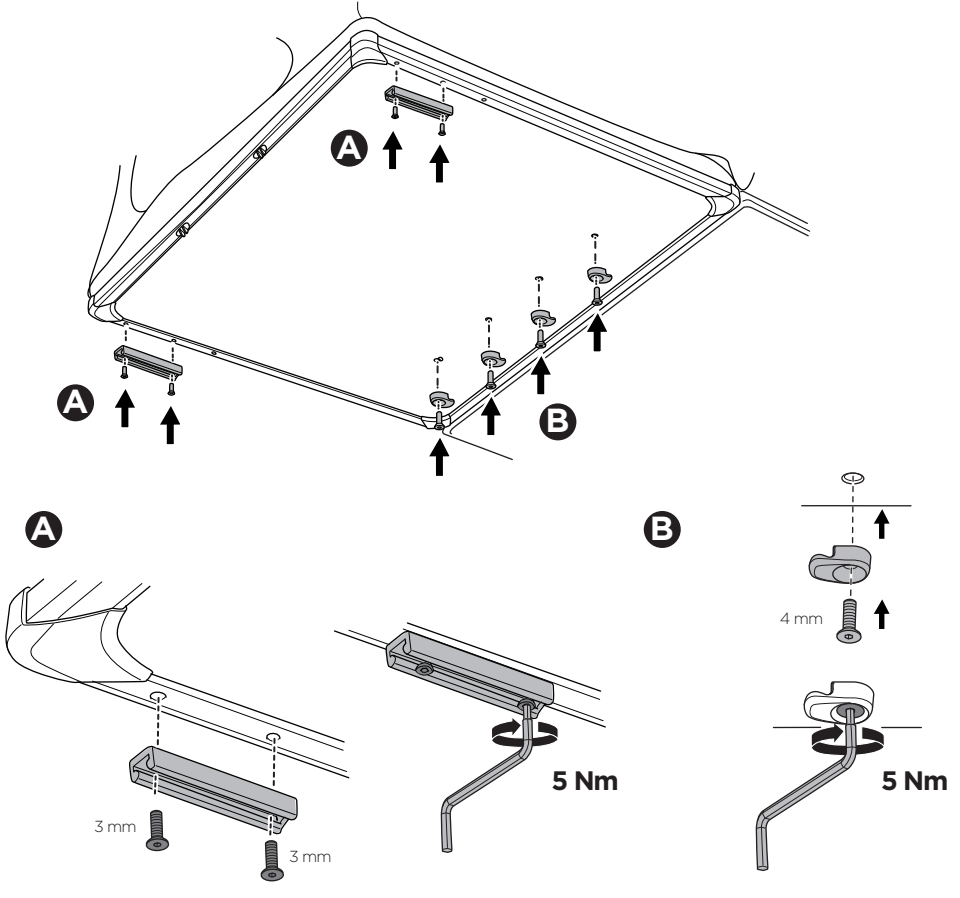
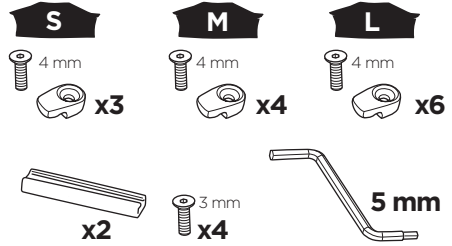
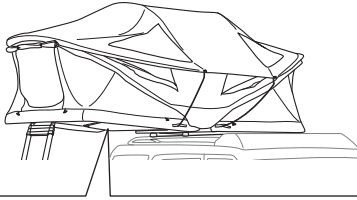

i

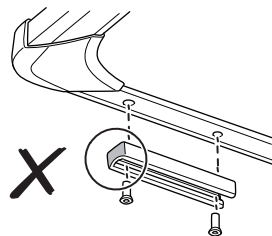
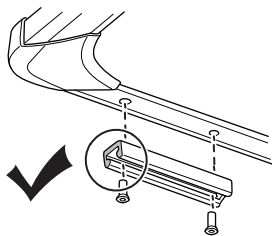

2

A

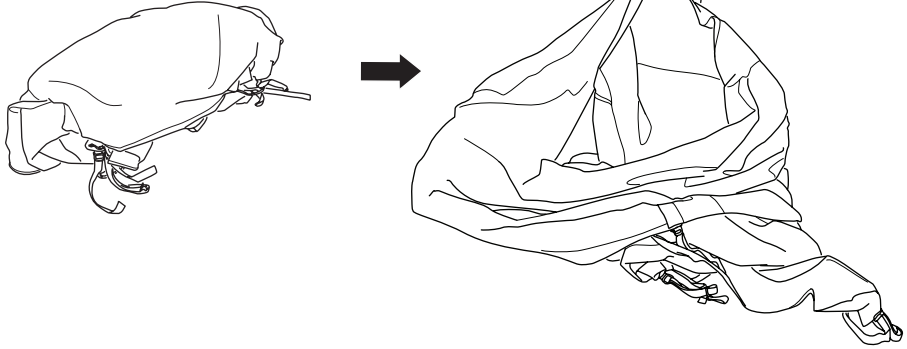

B

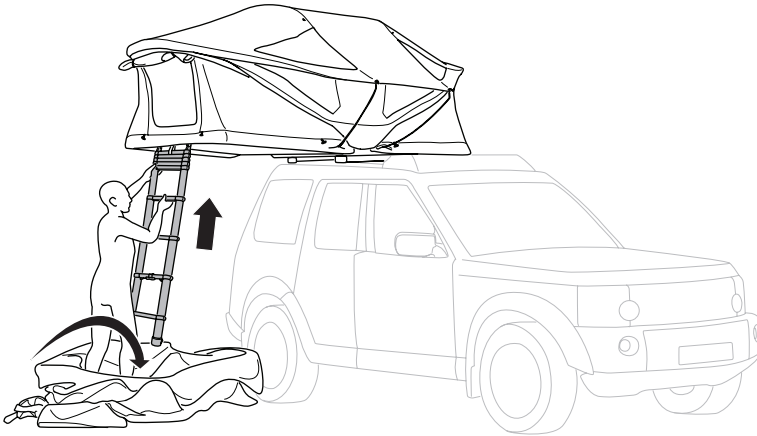

C



3

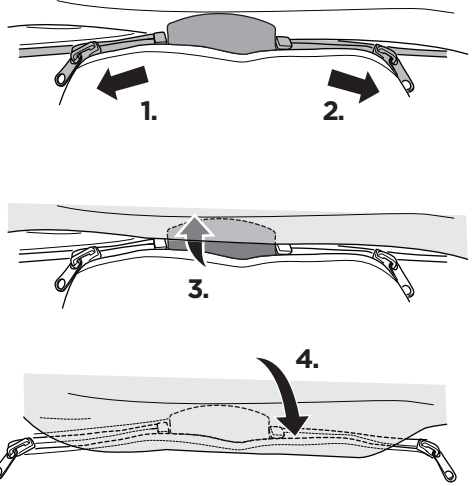
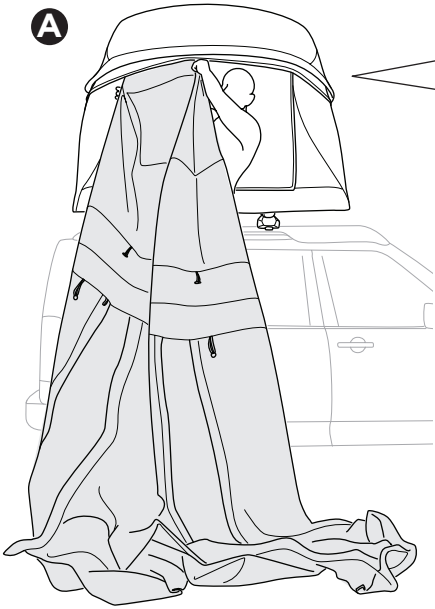

B

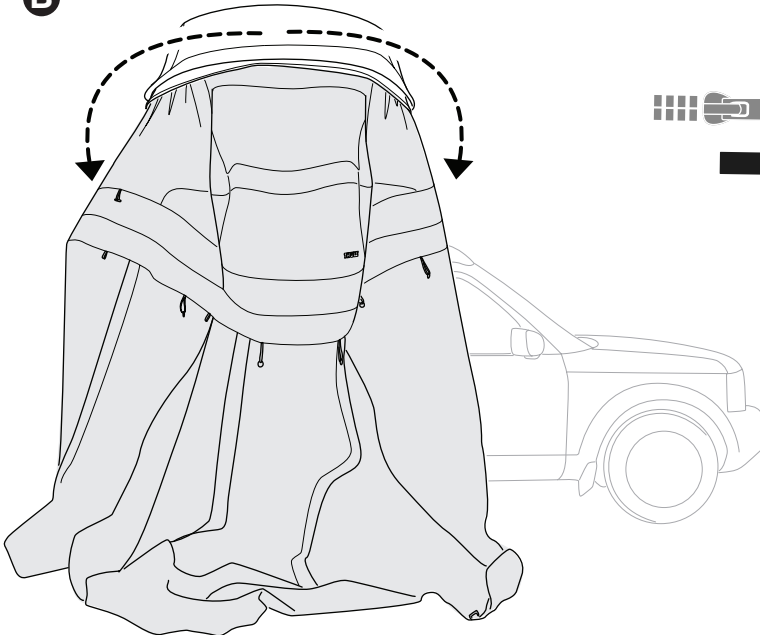

4

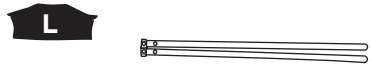

A

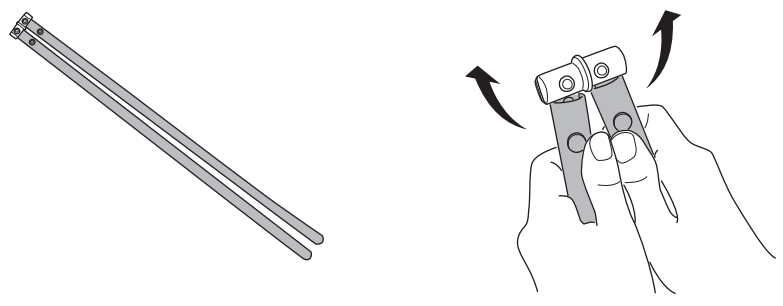

B

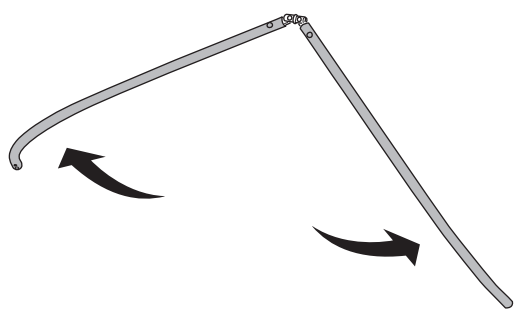

C

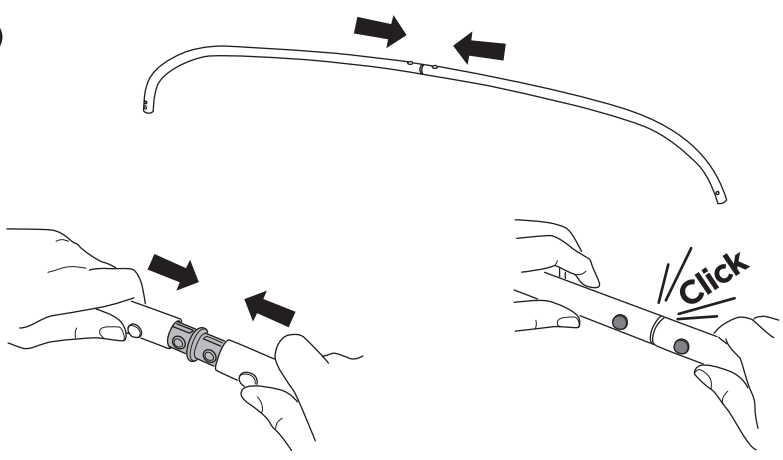

5

S M L

A

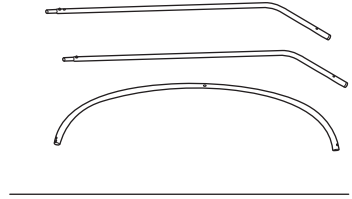
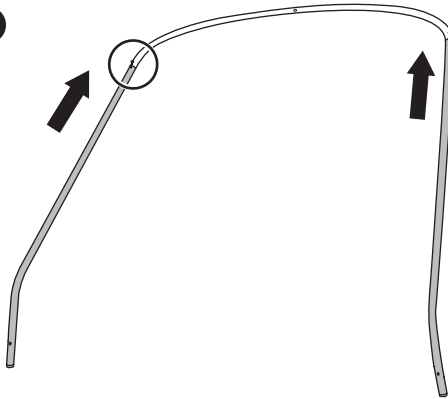

B

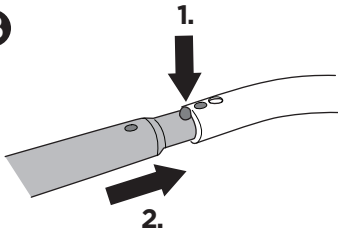

C

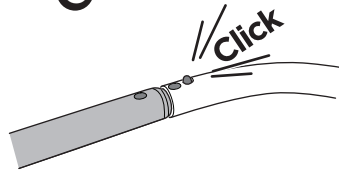

i

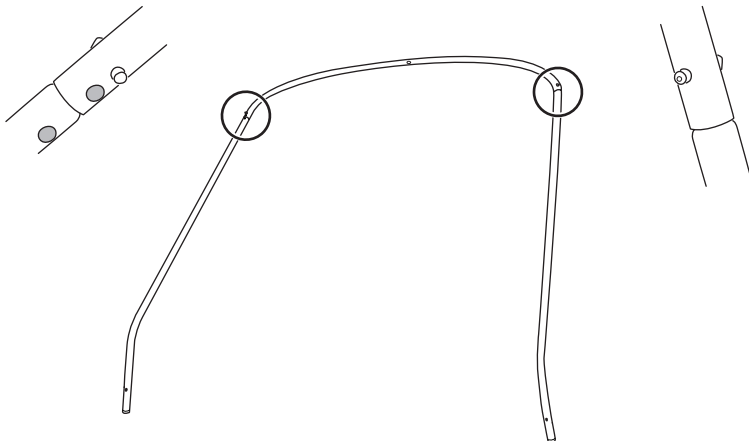

6

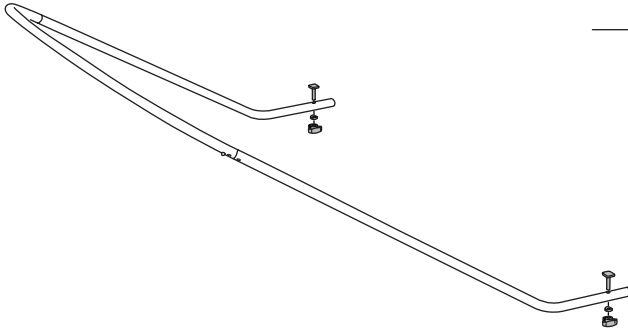

A

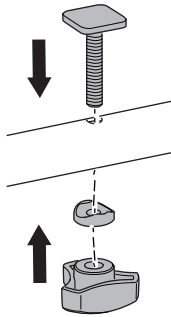

B

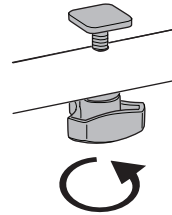

7

A



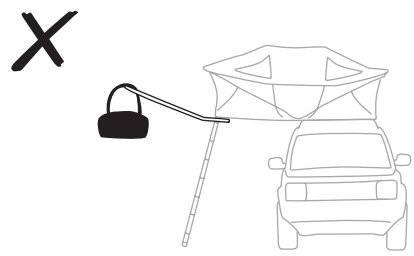
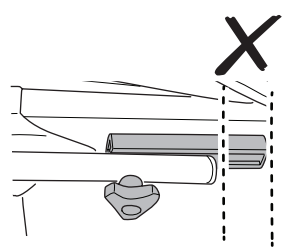
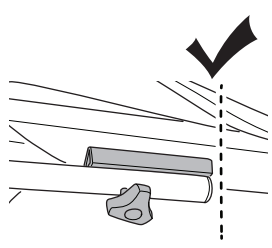
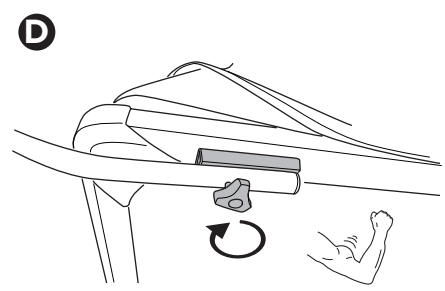
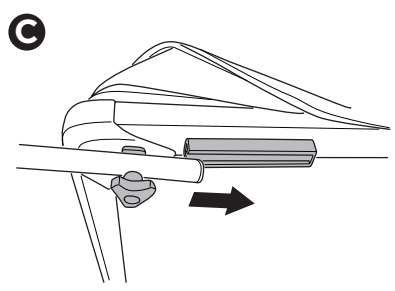
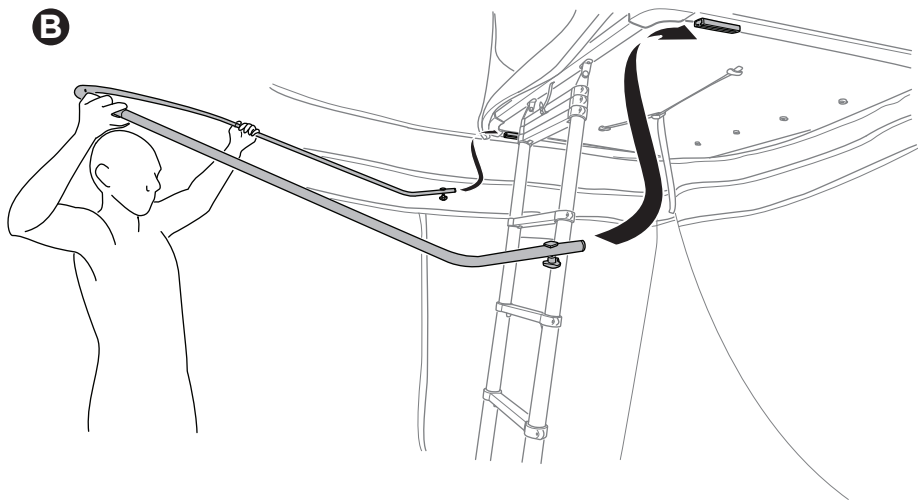

8

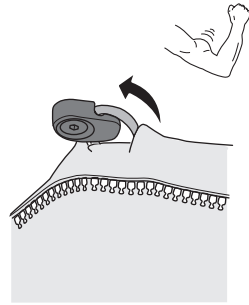
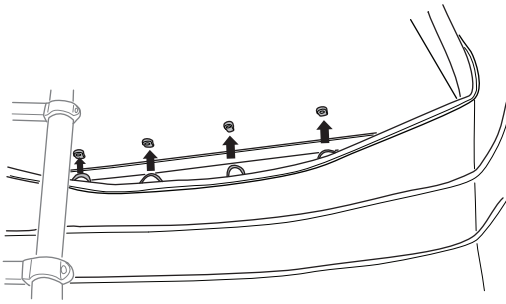
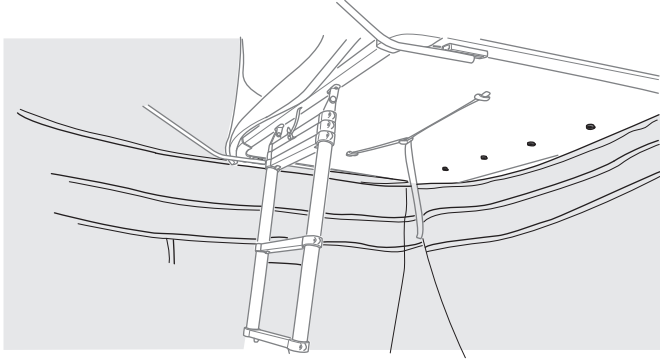

S
x3

M
x4

L
x6

i

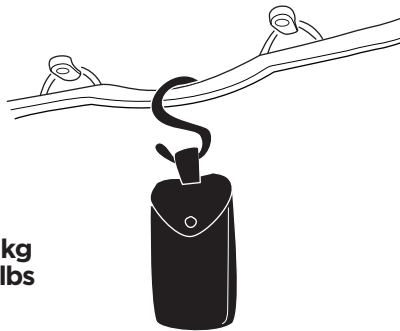

Max
20 kg
44 lbs

i

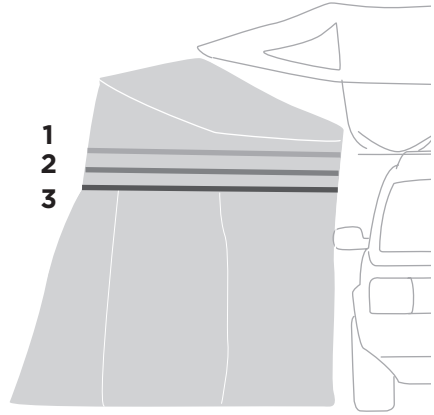
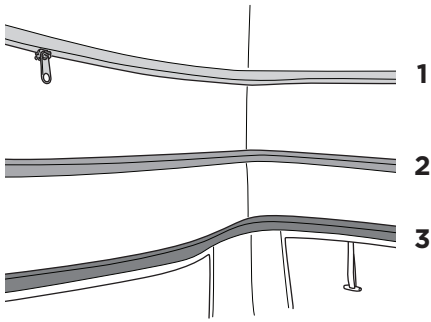
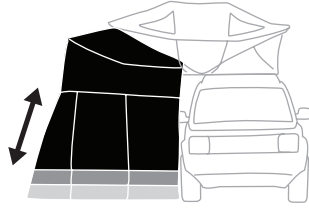

i

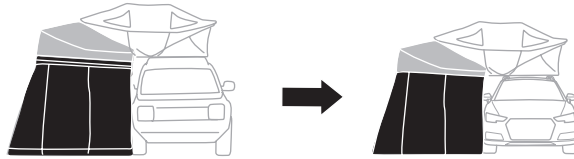

A

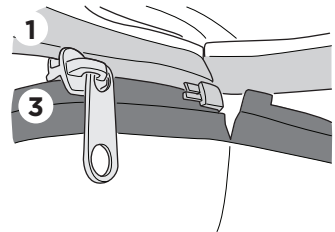
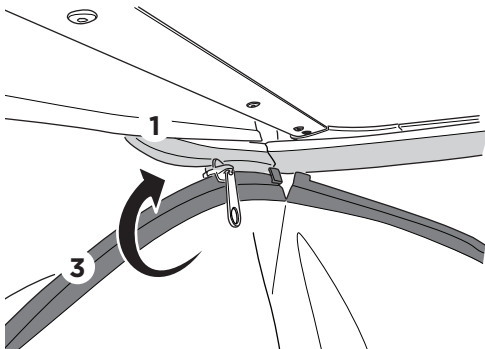

B

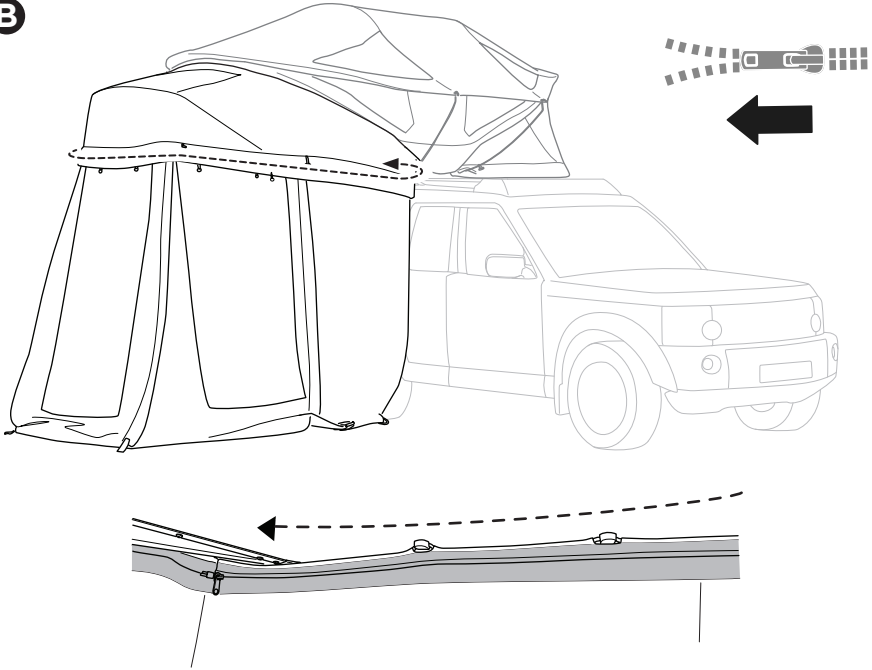

9



A

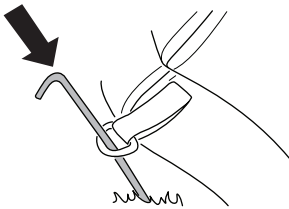

B

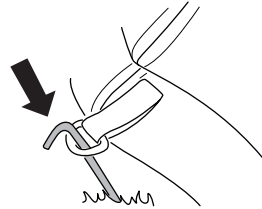

10

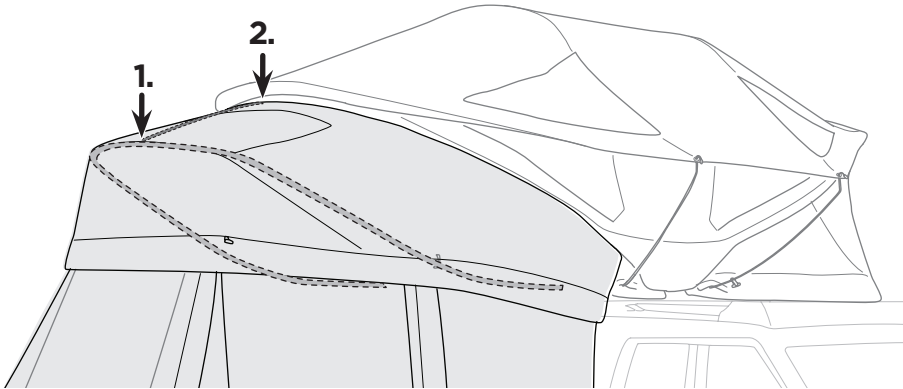

1.

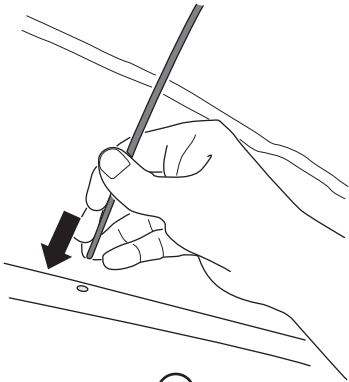

2.

A

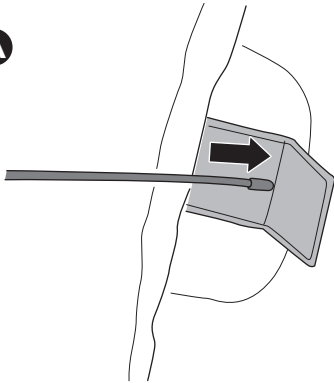

B

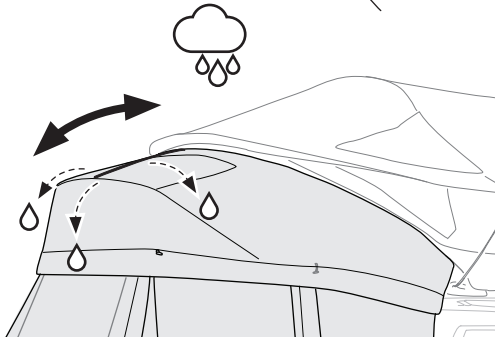
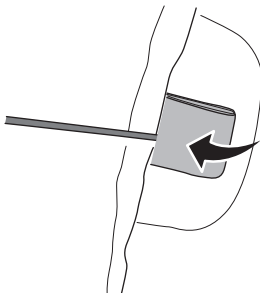

i

A



B

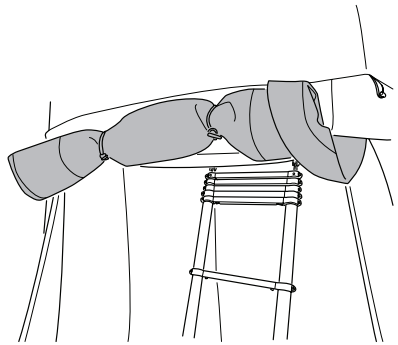

C

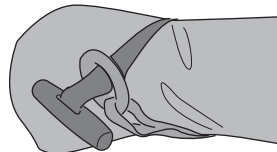

11

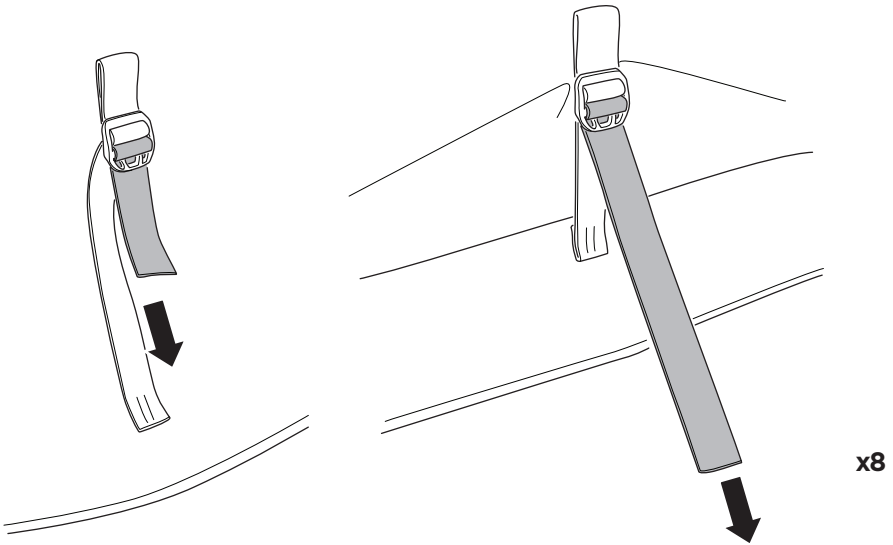

i

A



B



C

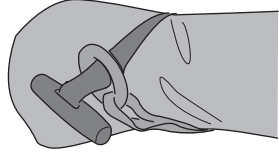

i



A

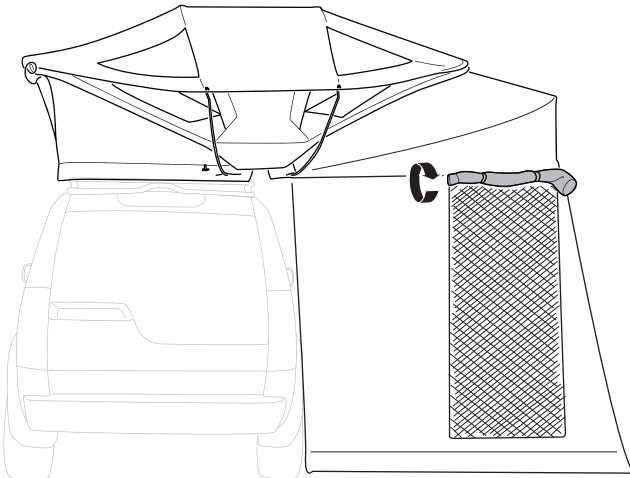

B

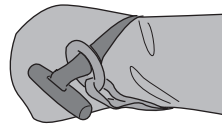

12

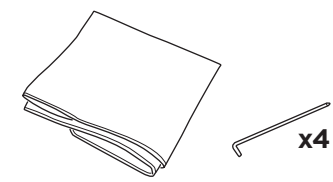

A

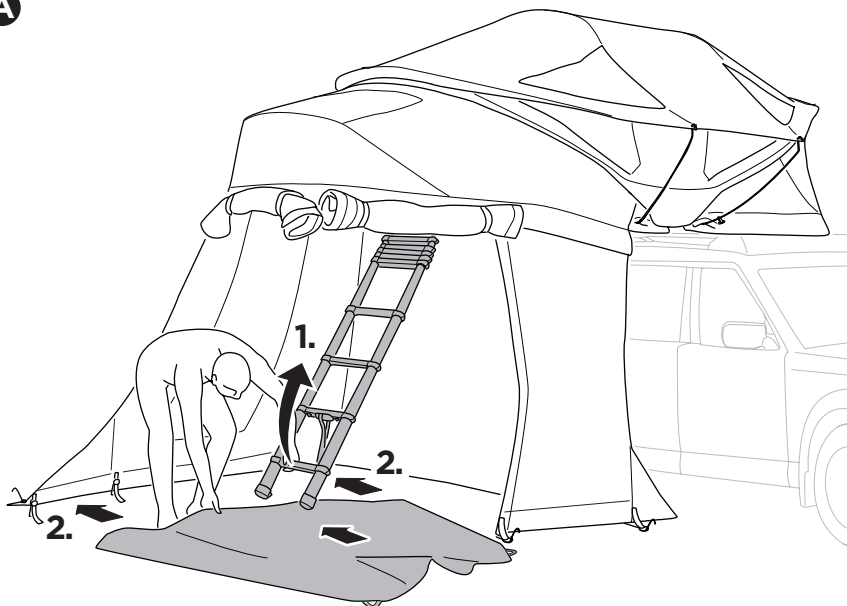

B

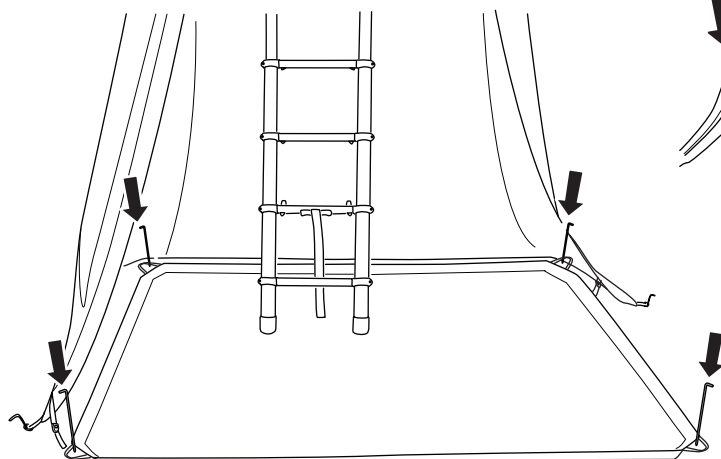

C

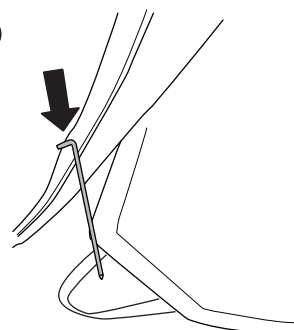

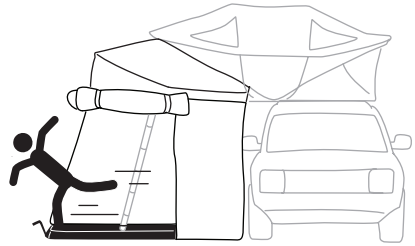
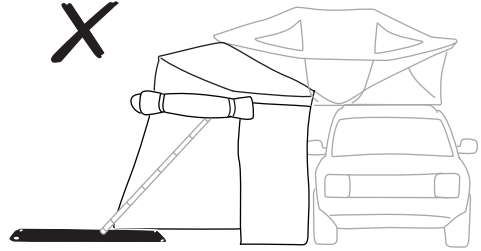
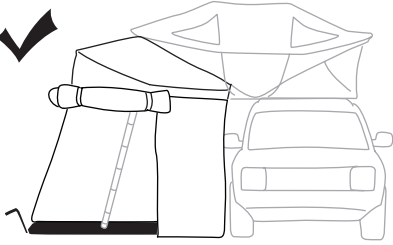

i

