

1

Kit 145005

MINI (F55), 5-dr Hatchback, 14-23



ISO 11154-E

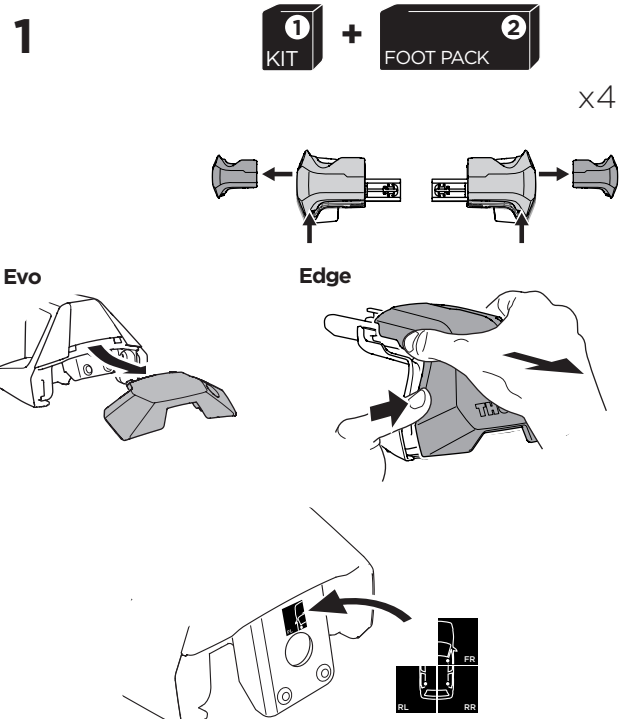
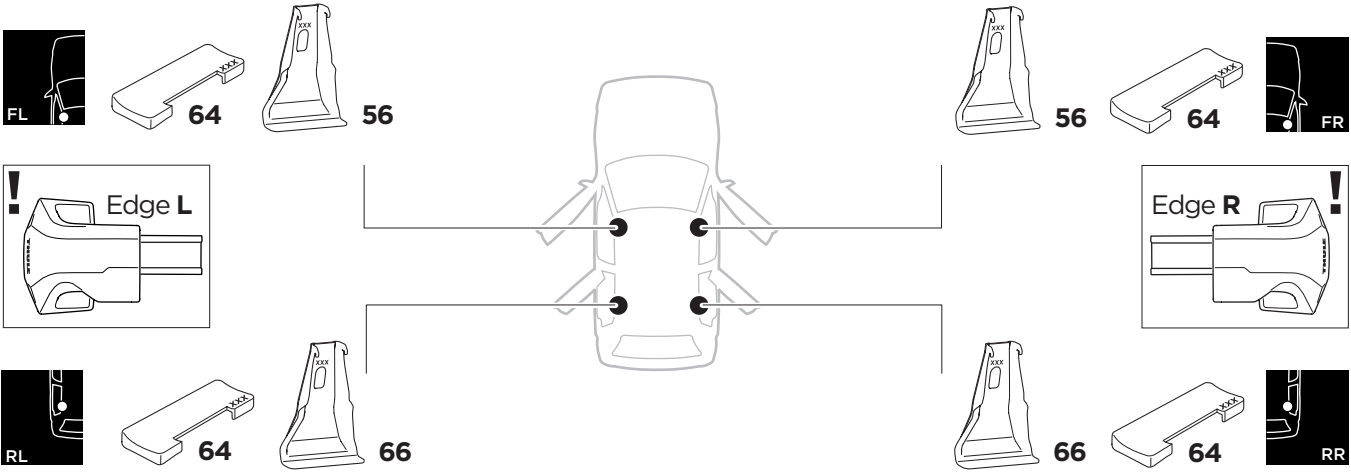
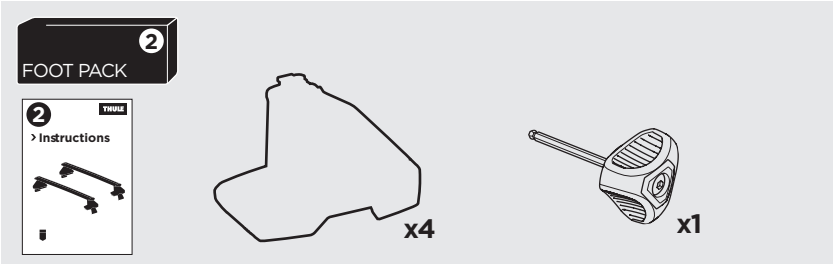
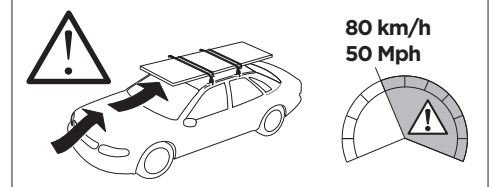
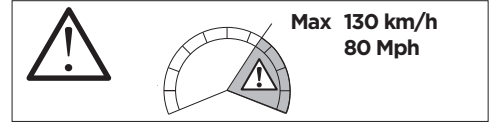
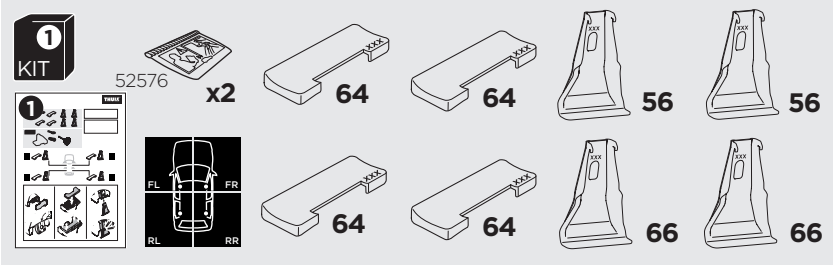



THULE WingBar Evo	THULE WingBar Edge	THULE WingBar	THULE SquareBar Evo	Evo X (scale)	Edge X (scale)
MINI (F55), 5-dr Hatchback, 14-23				28	E

THULE ProBar Evo	THULE SlideBar Evo	X (mm/inch)		
MINI (F55), 5-dr Hatchback, 14-23		931 mm / 36 5/8"		

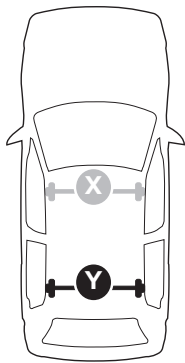

THULE WingBar Evo	THULE WingBar Edge	THULE WingBar	THULE SquareBar Evo	Evo Y (scale)	Edge Y (scale)
MINI (F55), 5-dr Hatchback, 14-23				26,5	H

THULE ProBar Evo	THULE SlideBar Evo	Y (mm/inch)		
MINI (F55), 5-dr Hatchback, 14-23		916 mm / 36 1/8"		

	W (mm/inch)	Z (mm/inch)
MINI (F55), 5-dr Hatchback, 14-23	700 mm / 27 1/2"	315 mm / 12 3/8"

