



Thule Rapid System Kit 1832

> Instructions

FORD Ka, 5-dr Hatchback, 14-

FORD Ka +, 4-dr Sedan, 14-

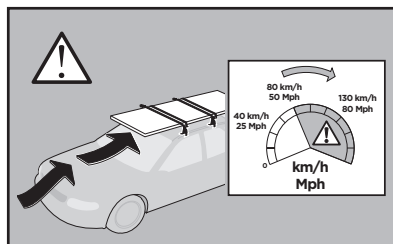
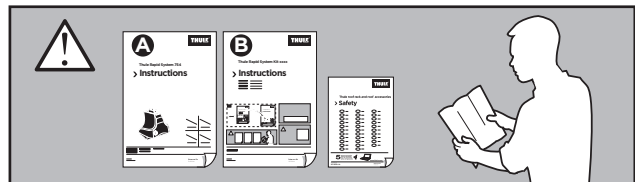
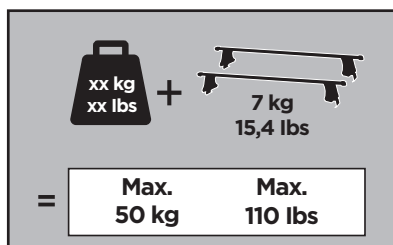
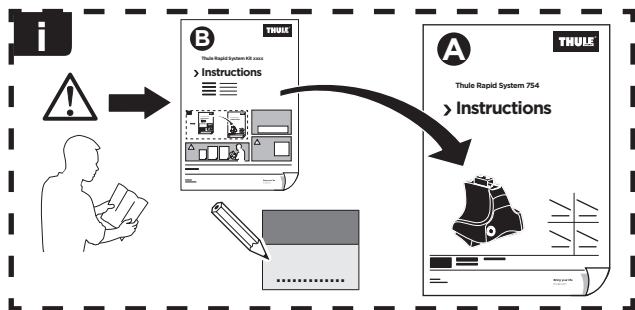

ISO 11154-E

141832
C.20160406
519-1832-01

Bring your life
thule.com



267 x1

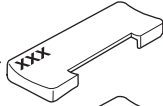

266 x1



341 x1



340 x1

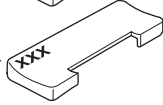

735 x2



186 x2



x1



x1

1

	X (scale)	X (mm)	X (inch)
FORD Ka , 5-dr Hatchback, 14-	35	1001	39 ³ / ₈
FORD Ka + , 4-dr Sedan, 14-	40	1051	41 ³ / ₈

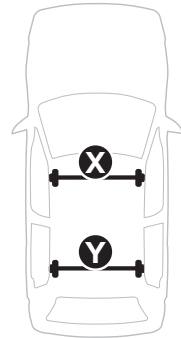
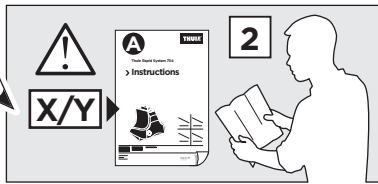
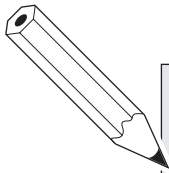

	Y (scale)	Y (mm)	Y (inch)
FORD Ka , 5-dr Hatchback, 14-	31	961	37 ⁷ / ₈
FORD Ka + , 4-dr Sedan, 14-	32	971	38 ¹ / ₄

2

FORD Ka, 5-dr Hatchback, 14-

FORD Ka +, 4-dr Sedan, 14-

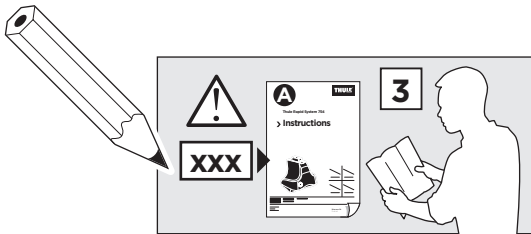
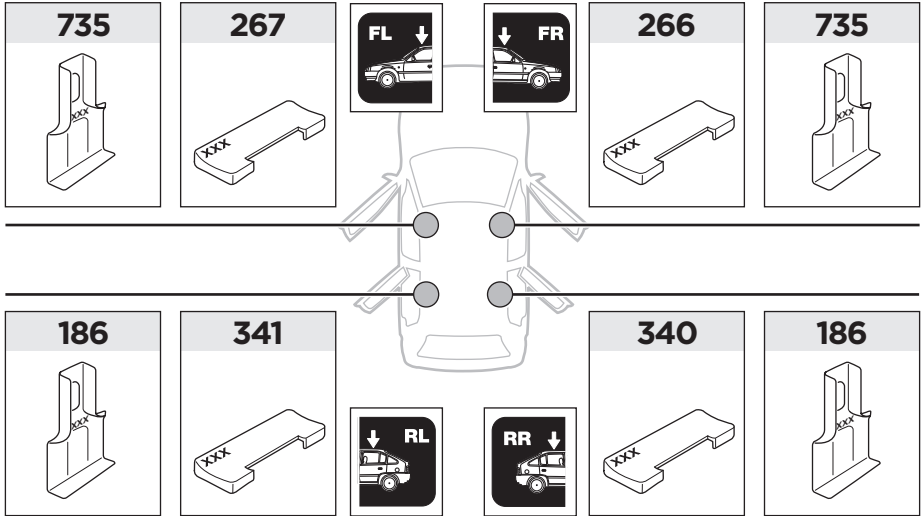

3

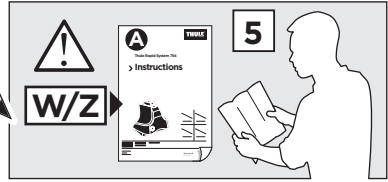

	W (mm)	Z (mm)	W (inch)	Z (inch)
FORD Ka , 5-dr Hatchback, 14-	300	650	11 3/4	25 5/8
FORD Ka + , 4-dr Sedan, 14-	250	700	9 7/8	27 1/2

