

➤ Instructions

Thule Force 3
645xxx

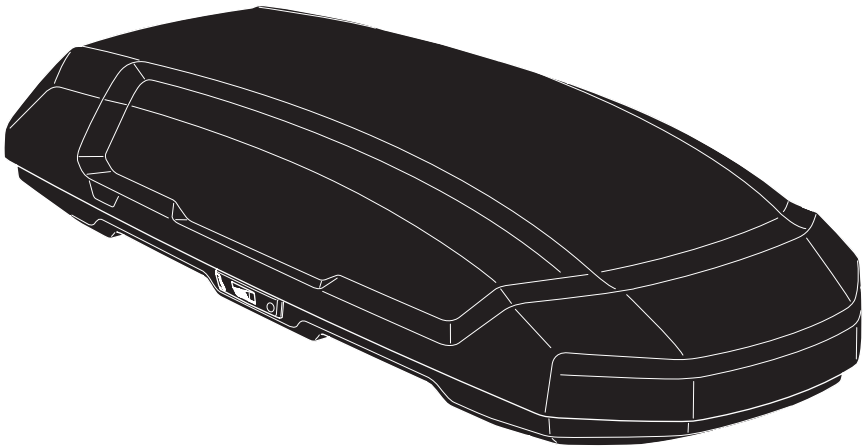

THULE.COM





EN

ROOF BOX FOR ROOF-MOUNTED RACKS

FAILURE TO COMPLY WITH THE MANUFACTURER'S INSTRUCTIONS CAN LEAD TO SERIOUS INJURY OR DEATH.

IMPORTANT - READ CAREFULLY AND KEEP FOR FUTURE REFERENCE.

 **WARNING** INDICATES A HAZARDOUS SITUATION WHICH, IF NOT AVOIDED, COULD RESULT IN DEATH OR SERIOUS INJURY.

 **NOTE** INDICATES ADDITIONAL INFORMATION THAT IS USEFUL FOR TROUBLE-FREE AND OPTIMAL USE OF THE PRODUCT

ES

COFRE PORTAEQUIPAJES PARA BARRAS DE TECHO

EL INCUMPLIMIENTO DE LAS INSTRUCCIONES DEL FABRICANTE PUEDE PROVOCAR LESIONES GRAVES O LA MUERTE.

IMPORTANTE - LEA ATENTAMENTE Y CONSERVELO PARA FUTURAS CONSULTAS.

 **ADVERTENCIA** INDICA UNA SITUACIÓN DE PELIGRO QUE, SI NO SE EVITA, PODRÍA PROVOCAR LESIONES GRAVES O INCLUSO LA MUERTE.

 **NOTA** INDICA INFORMACIÓN ADICIONAL QUE ES ÚTIL PARA UN USO ÓPTIMO Y SIN PROBLEMAS DEL PRODUCTO.

FR

COFFRE POUR BARRES DE TOIT

LE NON-RESPECT DES INSTRUCTIONS DU FABRICANT PEUT ENTRAÎNER DES BLESSURES GRAVES OU LA MORT.

IMPORTANT - LISEZ ATTENTIVEMENT CES INSTRUCTIONS ET CONSERVEZ-LES POUR RÉFÉRENCE FUTURE.

 **AVERTISSEMENT** INDIQUE UNE SITUATION POTENTIELLEMENT DANGEREUSE QUI, SI ELLE N'EST PAS ÉVITÉE, POURRAIT PROVOQUER DES BLESSURES GRAVES, VOIR MORTELLES.

 **REMARQUE** INDIQUE COMMENT RÉPONDRE À UNE SITUATION DONNÉE U VOUS DONNENT DES CONSEILS SUR LE FONCTIONNEMENT DES OPTIONS DISPONIBLES.

PT

CAIXA BAGAGEIRA PARA BARRAS DE TEJADILHO

O NÃO CUMPRIMENTO DAS INSTRUÇÕES DO FABRICANTE PODE LEVAR A FERIMENTOS GRAVES OU À MORTE.

IMPORTANTE - LEIA COM ATENÇÃO E GUARDE PARA REFERÊNCIA FUTURA

 **ATENÇÃO** INDICA UMA SITUÇÃO PERIGOSA QUE, SE NÃO FOR EVITADA, PODE RESULTAR EM MORTE OU FERIMENTOS GRAVES.

 **NOTA** INDICA INFORMAÇÕES ADICIONAIS QUE SÃO ÚTEIS PARA O USO IDEAL E SEM PROBLEMAS DO PRODUTO.



x1

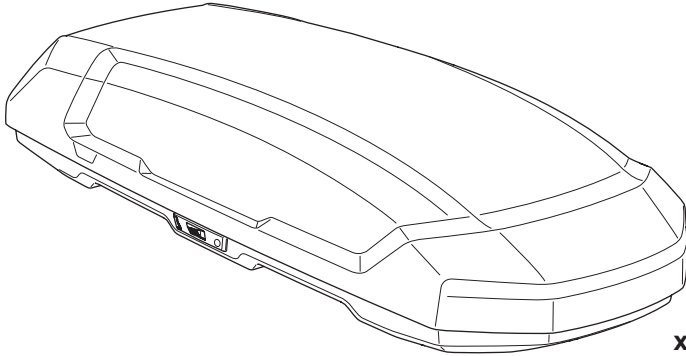

x1

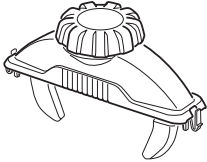

x4

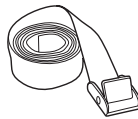

x3



x2

i



Your Key-Number

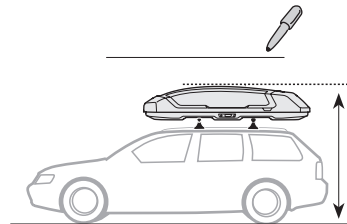

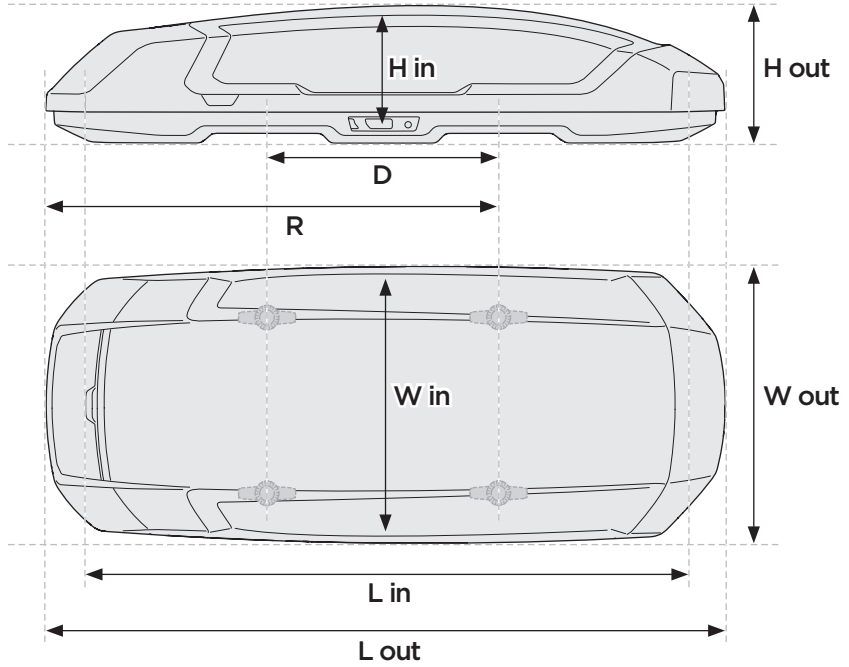

		D Min	D Max	L out	W out	H Out	R Min	L in	W in	H in
M	mm	555	930	1753.1	812.1	443.5	1149	1671.3	694.4	384.5
	inch	21 ⁷ / ₈	36 ⁵ / ₈	69	32	17 ¹ / ₂	45 ¹ / ₄	65 ³ / ₄	27 ³ / ₈	15 ¹ / ₈
L Sport	mm	555	930	1910.80	627.70	423.50	1265	1828.7	512.1	365.3
	inch	21 ⁷ / ₈	36 ⁵ / ₈	75 ¹ / ₄	24 ³ / ₄	16 ⁵ / ₈	49 ³ / ₄	72	20 ¹ / ₈	14 ³ / ₈
L	mm	555	930	1951.5	845.3	425.8	1285	1869.7	727.9	366.8
	inch	21 ⁷ / ₈	36 ⁵ / ₈	76 ⁷ / ₈	33 ¹ / ₄	16 ³ / ₄	50 ⁵ / ₈	73 ⁵ / ₈	28 ⁵ / ₈	14 ¹ / ₂
XL	mm	555	930	2153.1	868.3	470.1	1347	2071	749.5	373.5
	inch	21 ⁷ / ₈	36 ⁵ / ₈	84 ³ / ₄	34 ¹ / ₈	18 ¹ / ₂	53	81 ¹ / ₂	29 ¹ / ₂	14 ³ / ₄
XXL	mm	555	930	2321.1	894.3	454.2	1432	2238.8	774.6	394.8
	inch	21 ⁷ / ₈	36 ⁵ / ₈	91 ³ / ₈	35 ¹ / ₄	17 ⁷ / ₈	56 ³ / ₈	88 ¹ / ₈	30 ¹ / ₂	15 ¹ / ₂

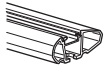

Thule WingBar Evo

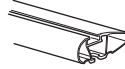

Thule WingBar

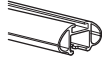

Thule AeroBar



Thule Squarebar



Thule SlideBar

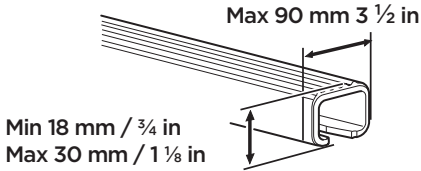

Thule T-track Adapter
696600
697604

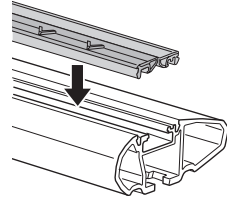
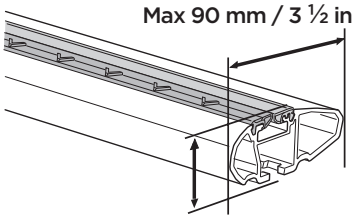
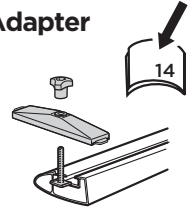

Max 75 kg / 165 lbs

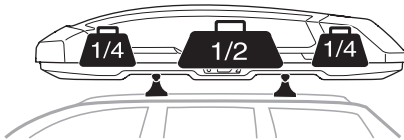

	Weight		Volume
M	16.8 kg	37 lbs	408 litre
L Sport	15.4 kg	34 lbs	312 litre
L	19.5 kg	43 lbs	445 litre
XL	22.2 kg	49.6 lbs	515 litre
XXL	25.9 kg	57 lbs	604 litre

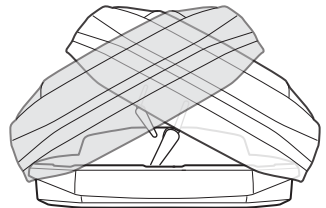

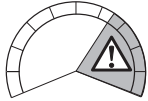
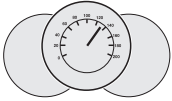
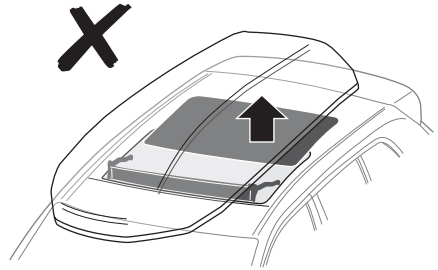
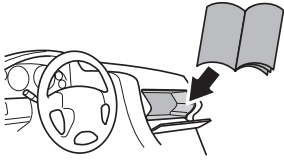

Max
130 km/h
81 mph

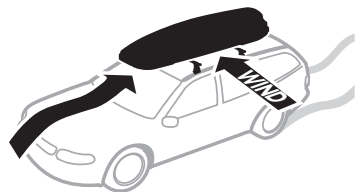
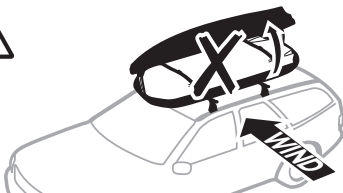
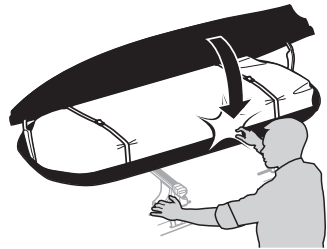
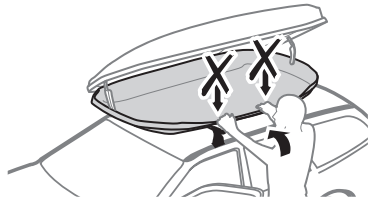
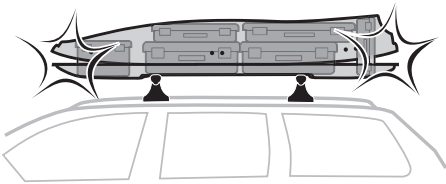

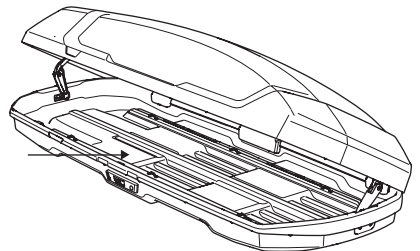
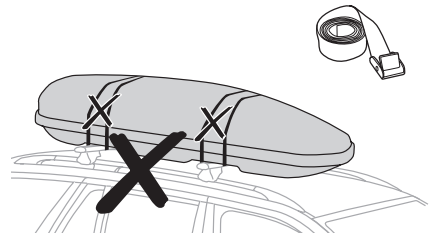
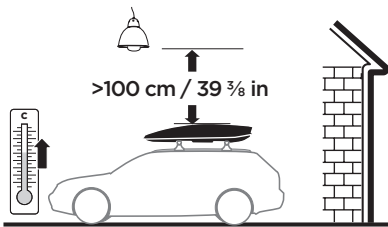
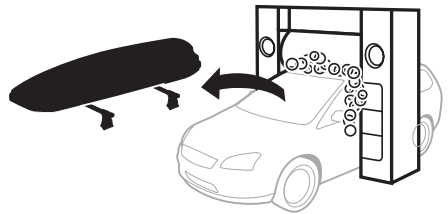
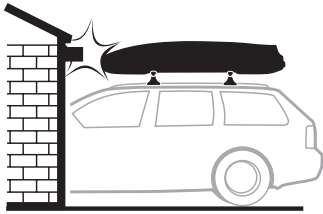
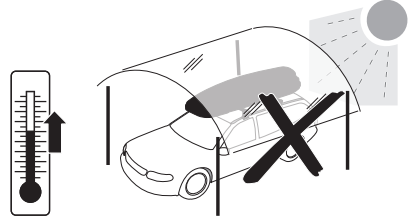
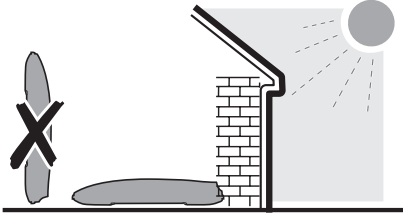

1

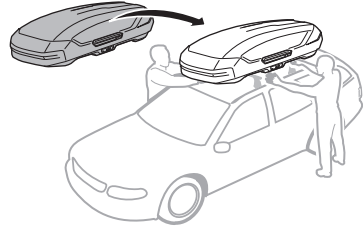

2

A

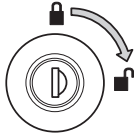

B

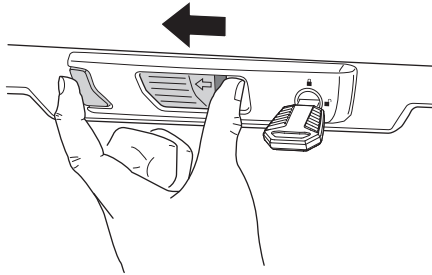

C

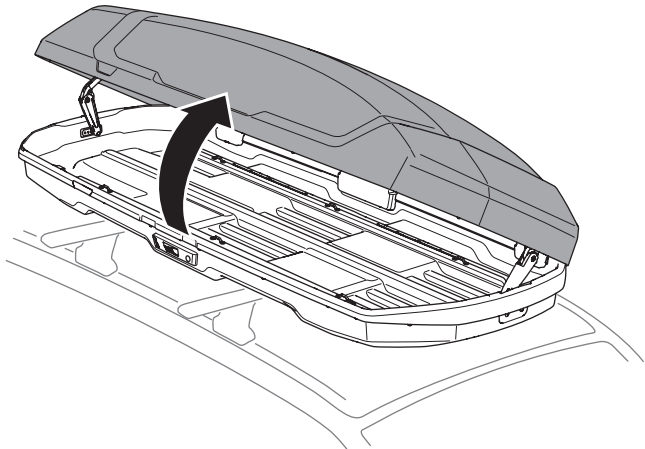

3

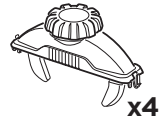

A

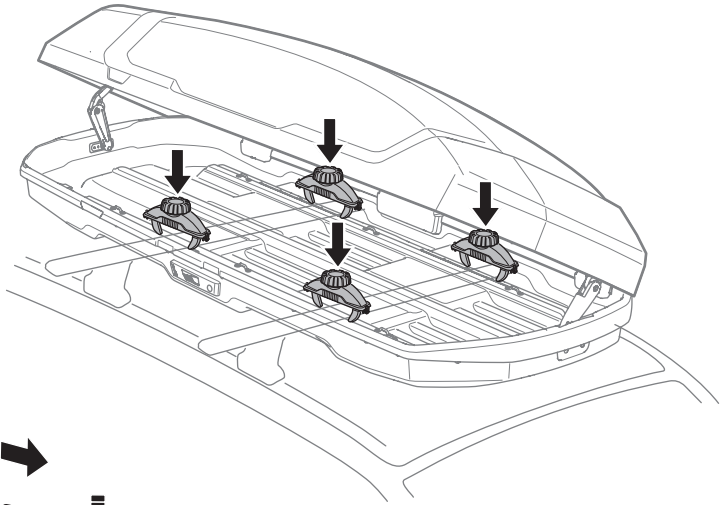
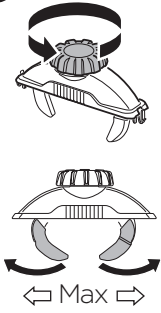

B

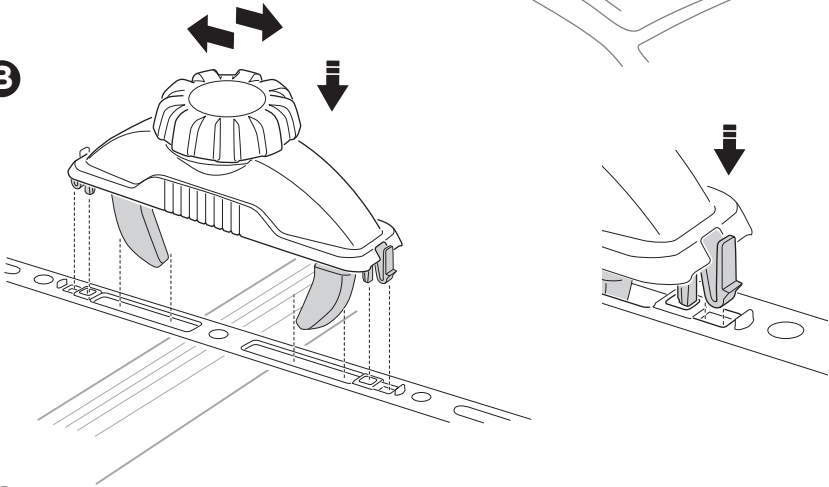

C

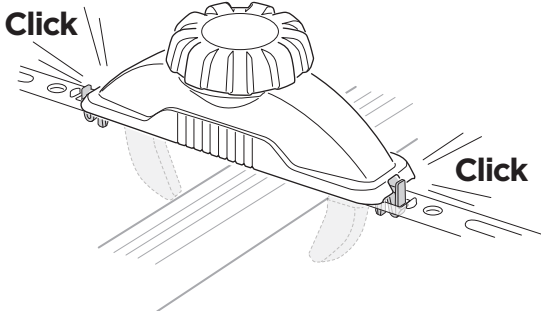

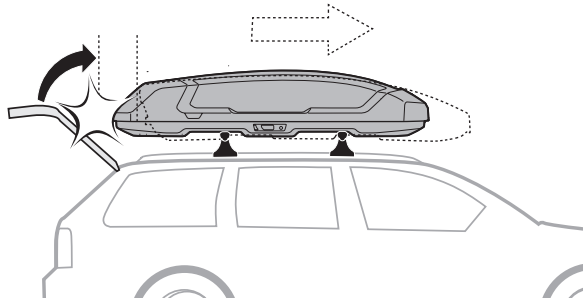

ok

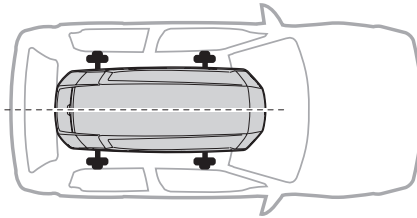

Not ok

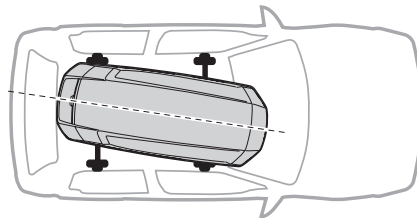

Not ok

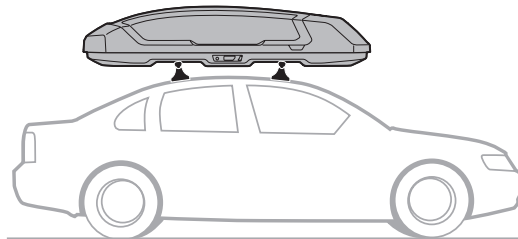

4

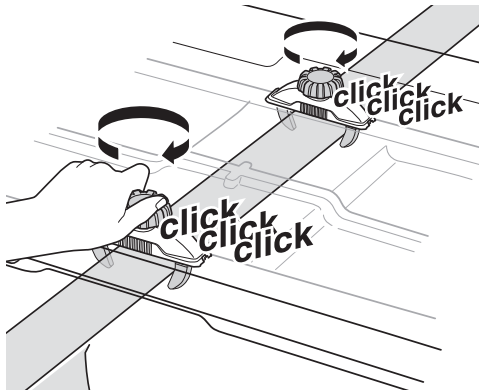
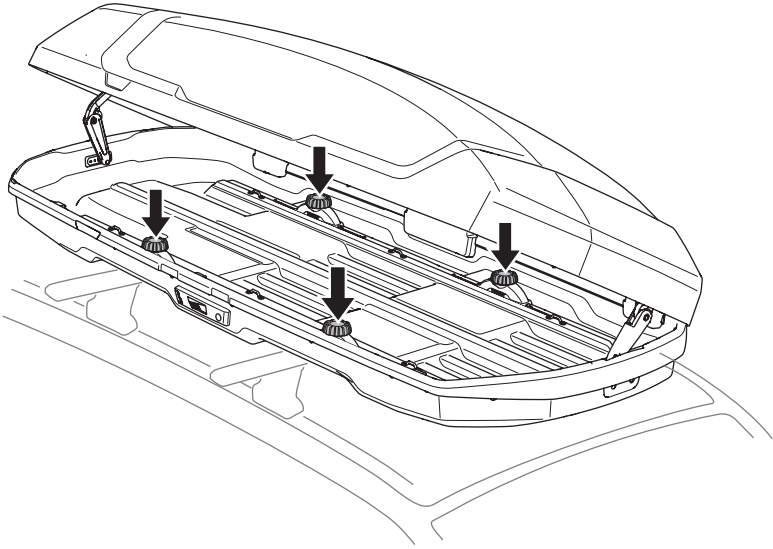

ok
✓

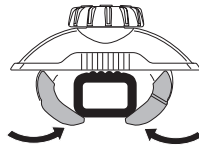
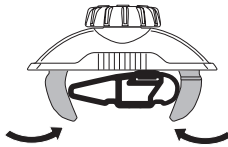

Not ok
✗

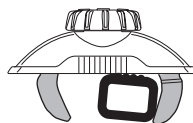
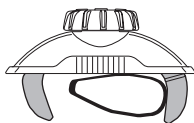

5

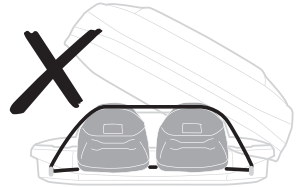
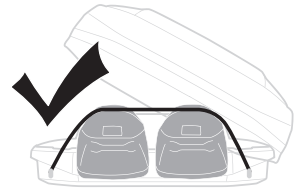
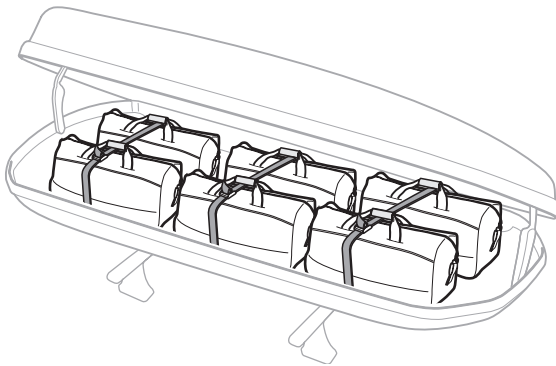
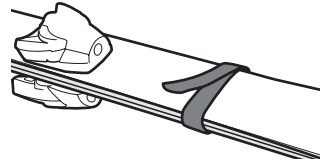
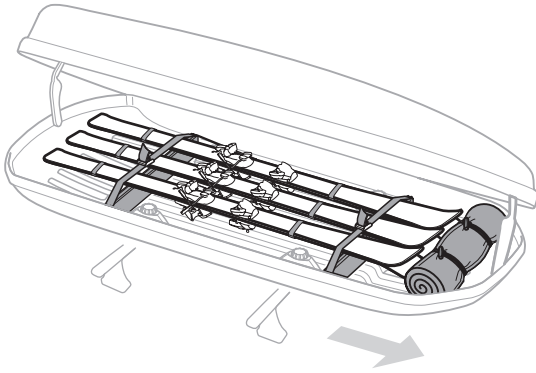

Not ok
X

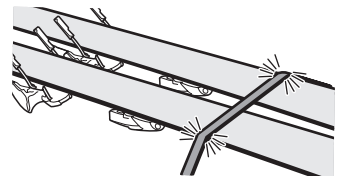
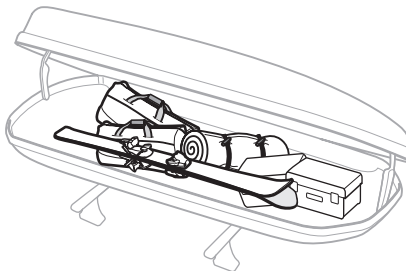

6

A

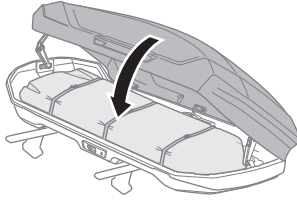

B

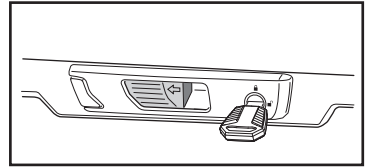
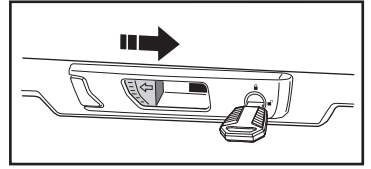
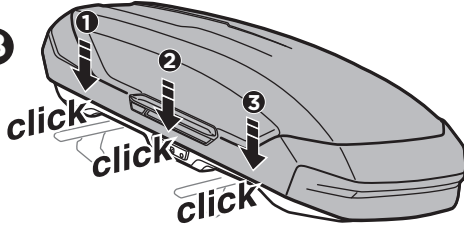

C

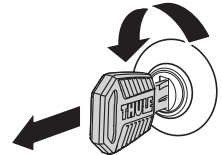
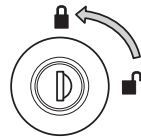
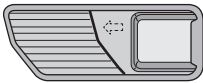
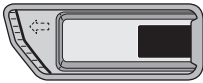
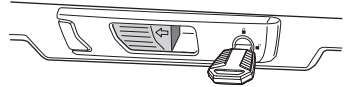

7

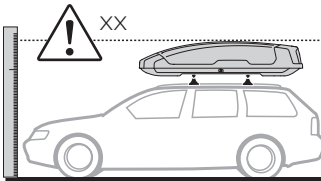

x1

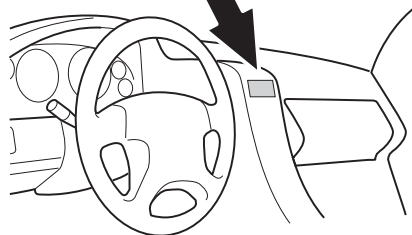

Thule lid pull straps
695900

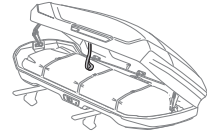
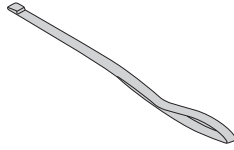

Thule box light
695200

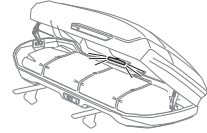
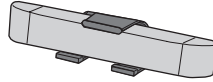

Thule T-track Adapter

696600 ⇒ 24x30 mm
 $1\frac{15}{16} \times 1\frac{3}{16}$ inch

697604 ⇒ 20x27 mm
 $2\frac{25}{32} \times 1\frac{1}{16}$ inch

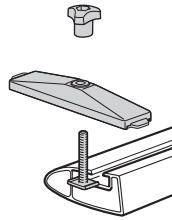

20-24
 $2\frac{25}{32} - 1\frac{15}{16}$

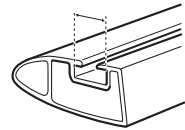

Thule MultiLift
572004

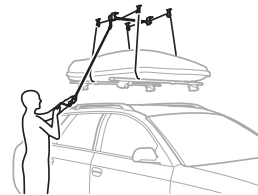
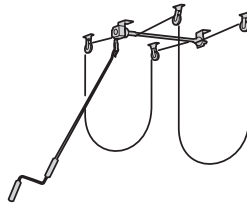

Thule Box Ski Carrier Adapter

694500 ⇒ L Sport

694800 ⇒ M, L

694900 ⇒ XL, XXL

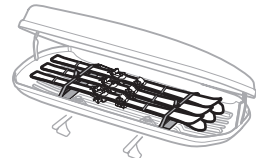
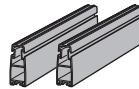

Thule GoPack duffel set
800604



Thule Box Lid Cover

- 698100 → M, L, L Sport
 698400 → XL, XXL Sport

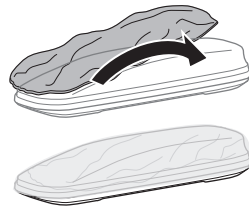

Thule One-Key System

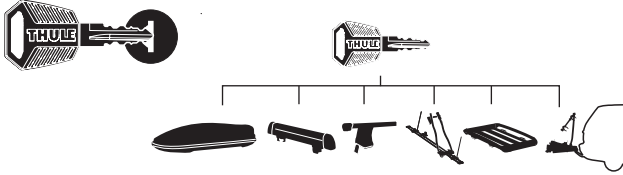

- 450400 (x4)
 450600 (x6)
 450800 (x8)
 451200 (x12)
 451600 (x16)

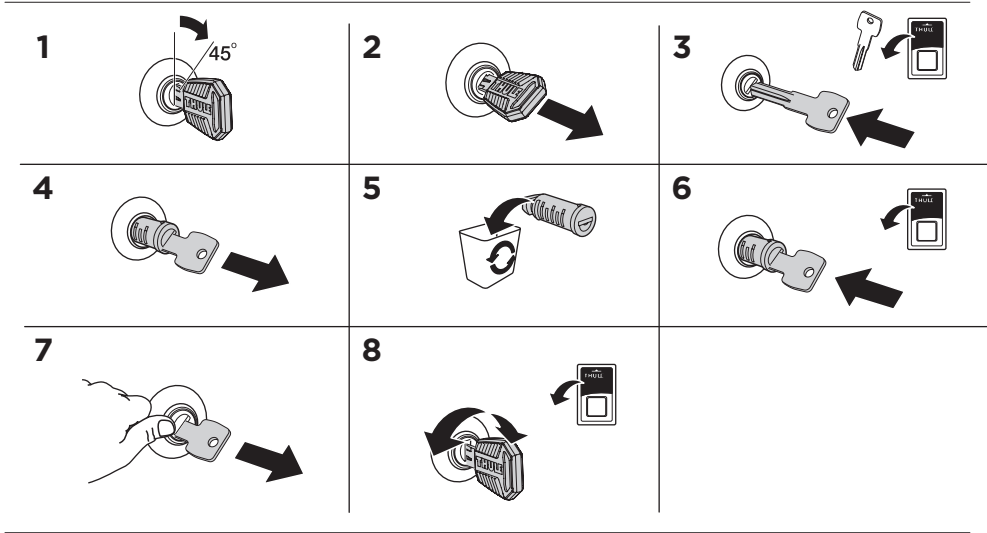

EN Spare parts FR Pièces détachées ES Repuestos PT Peças de reposição

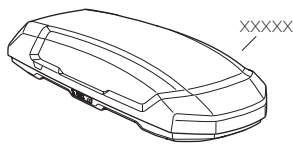

→ Thule.com

A.0 SECURITY REGULATIONS

- A.1 Check at regular intervals (depending on the state of the roads) both before and during each journey that the roof box is firmly fixed to the roof rack, the load adequately secured, the roof box locked and the key removed from the lock.
- A.2 Make sure the roof box is closed and locked and the key removed from the lock before driving off.
- A.3 If left unsupervised, check all locks, load and fixation of the box to make sure it is in the correct condition.
- A.4 Inadequately secured loads and incorrectly mounted roof racks and roof boxes can come loose during a journey and cause serious accidents!
- A.5 Ensure you give due consideration to the change in height and drive behaviour (side-wind sensitivity, corner and braking behaviour) of the given vehicle when a roof rack and/or roof box is/are mounted and, above all, loaded. No further loads may be attached to the exterior of the roof box.
- A.6 The total permissible laden weight of the given motor vehicle may not be exceeded. The instructions of the motor vehicle manufacturer in respect of the maximum roof weight must be observed.
- A.7 Calculation of allowed roof load:
Weight of roof rack
+ weight of roof box
+ weight of payload
= available roof load
- A.8 The vehicle's speed must always be adjusted to the load being carried and the current driving conditions, such as the road type, road quality, wind conditions, traffic intensity and applicable speed limits, but must under no circumstances exceed 130 km/h. Applicable speed limits and other traffic regulations must always be observed.
- A.9 The roof box should be carefully cleaned and maintained, particularly during the winter months. For this purpose, only use a solution of water and standard household washing liquid without any alcohol, bleach or ammonium additives as otherwise the surface of the roof box could suffer damage. Please do not use any standard cockpit sprays for cleaning the roof box. The locks should be lubricated with spray lubricant (no lubricant should be allowed to come into contact with the plastic surface of the roof box).

B.0 PLEASE NOTE THE FOLLOWING WHEN USING THE ROOF BOX:

- B.1 The height of the given vehicle can increase by up to 700 mm (depending on the roof rack used)
- B.2 Beware of low garage entrances, low clearances in general, low-hanging branches, etc!
- B.3 Wind noise may be generated.
- B.4 When using an automatic car-wash facility, the roof box and roof rack must first be removed.
- B.5 In addition to these usage instructions, due consideration should also be given to mounting instructions for the given roof rack and the operating instructions of the given vehicle!
- B.6 For reasons of fuel economy and the safety of other road users, the roof box and roof rack should be removed when not in use.
- B.7 For your own safety, you should only use tested (e.g. GS-tested) roof racks that are authorised for usage in conjunction with your vehicle.
- B.8 The roof box must be mounted with the front facing the driving direction.
- B.9 In order to avoid generating excessive lifting forces, the roof box must be mounted parallel to the line of the road and not at an angle.
- B.10 If no special fitting positions are given in the assembly instructions, try to maintain a minimum distance of 700 mm between the load carrier bars. Please note that changes (e.g. additional drill holes) to the roof box fixation system are not permissible.

C.0 MAINTENANCE

- C.1 These usage instructions should be kept together with the given vehicle's operating instructions and carried in the vehicle when in use and en route. Any changes made to the mounting sets and roof box as well as the use of spare parts or accessories other than those supplied by the manufacturer will lead to the manufacturer's warranty and liability for any material damage or accidents lapsing! You should therefore observe these usage instructions to the letter and only use the original parts supplied. In the event of you losing parts or parts wearing out, you should only replace them with original spare parts that can be obtained from a specialist stockist or the manufacturer.
- C.2 To assure the rapid provision of spare parts and avoid any time-consuming queries, we would ask you to indicate the so-called „BA No.“ whenever you order spare parts or have a query. This „BA No.“ can be found on a sticker located inside the roof box lid.
- C.3 In order to ensure that you are able to replace any lost or defective keys as quickly as possible, it is advised that you note down the key numbers.
- C.4 The roof box should not be stored outside exposed to the elements (e.g. rain or direct sunlight).
- C.5 The manufacturer is not liable for any damage or accident that may occur as a result of non-compliance with these usage instructions, changes made to parts or usage of any parts other than the manufacturer's original parts!

A.0 INSTRUCTIONS IMPORTANTES

- A.1 Vérifier que le coffre de toit est solidement fixé aux barres de toit avant le départ et à intervalles raisonnables en cours de route (en fonction de l'état de la chaussée). La charge doit être convenablement immobilisée, le coffre de toit fermé et la clé retirée de la serrure.
- A.2 Assurez-vous que le coffre de toit est fermé et verrouillé, et que la clé est retirée de la serrure avant le départ.
- A.3 Si laissé sans surveillance, vérifiez toutes les serrures, la charge et la fixation du coffre pour vous assurer qu'il est en bon état.
- A.4 Une charge insuffisamment arrimée, un coffre de toit ou des barres de toit mal fixés, peuvent se détacher en cours de route et provoquer de graves accidents !
- A.5 Tenir compte de la modification de la hauteur et du changement de tenue de route du véhicule (sensibilité au vent latéral, virages, freinage) lorsque que le coffre de toit est monté, et tout particulièrement si ce dernier est chargé. Aucune autre charge ne doit être fixée sur l'extérieur du coffre de toit.
- A.6 Ne pas dépasser le poids total autorisé en charge (PTAC) du véhicule. Les consignes du constructeur du véhicule concernant la charge de toit maximale doivent être respectées :
- A.7 Détermination de la charge de toit effective :
- poids des barres de toit
 - + poids du coffre de toit
 - + poids de la charge transportée
 - = charge de toit effective
- A.8 La vitesse du véhicule doit constamment être ajustée en fonction du chargement transporté et des conditions de route, telles que le type et la qualité de la route, les conditions météorologiques, l'intensité du trafic et les limitations de vitesse en vigueur, mais ne doit en aucun cas dépasser 130 km/h. Les limitations de vitesse applicables et l'ensemble de la législation routière en vigueur doivent toujours être observées.
- A.9 Le coffre de toit doit être soigneusement nettoyé et entretenu, particulièrement pendant les mois d'hiver. Pour le nettoyage, utilisez uniquement de l'eau et un détergent du commerce sans additifs, tels qu'alcool, chlore ou ammoniac, qui risqueraient d'endommager la surface du coffre de toit. Ne pas utiliser d'aérosol pour tableaux de bord pour nettoyer le coffre de toit. Nous conseillons de lubrifier les serrures avec de la graisse en aérosol (la graisse ne doit pas entrer en contact avec les surfaces plastiques).

B.0 LORS DE L'UTILISATION DU COFFRE DE TOIT TENIR COMPTE DES REMARQUES SUIVANTES

- B.1 L'augmentation de la hauteur du véhicule peut atteindre 700 mm (en fonction des barres de toit)
- B.2 Faire attention dans les entrées de garage, les passages bas, les branches basses etc.
- B.3 Des bruits de vents peuvent se produire pendant la conduite.
- B.4 Le coffre de toit et les barres de toit doivent être démontés avant de laver le véhicule dans une station de lavage automatique.
- B.5 Tenir compte, en plus des remarques de ce mode d'emploi, des instructions de montage des barres de toit et du manuel d'utilisation du véhicule !
- B.6 Pour éviter une surconsommation de carburant et pour la sécurité des autres usagers de la route, nous vous recommandons de démonter le coffre et les barres de toit en cas non-utilisation.
- B.7 Pour votre propre sécurité n'utiliser que des barres de toit agréées (homologation GS par ex.) pour votre véhicule.
- B.8 Le coffre de toit doit être monté avec son coté avant orienté vers la direction de conduite.
- B.9 Afin d'éviter une altération de la tenue de route (portance accrue), le coffre de toit doit être monté sans angle d'incidence (le plus parallèle possible à la chaussée).

- B.10 Si aucune indication n'est précisée sur le positionnement des barres sur toit, essayer de maintenir un écartement minimum de 700 mm entre les deux barres. Veuillez noter que toute modification du dispositif de fixation du coffre de toit est interdite (perçages supplémentaires par. ex.).

C.0 CONDUITE ET RÉGLEMENTATION

- C.1 Conserver ce mode d'emploi avec le manuel d'utilisation du véhicule, à bord du véhicule. Toute modification des dispositifs de fixation et du coffre de toit, ainsi que l'utilisation de pièces de rechange et d'accessoires autres que ceux du fabricant, annule la garantie et le dégage de toute responsabilité concernant les dégâts matériels et les accidents ! Il est donc indispensable de suivre les indications du mode d'emploi et de n'utiliser que les pièces d'origine fournies. En cas de perte ou d'usure de pièces, n'utiliser que des pièces de rechanges d'origine disponibles chez un distributeur spécialisé ou directement chez le fabricant.
- C.2 Afin d'assurer une fourniture rapide des pièces et pour éviter les longues demandes d'information supplémentaires, nous vous prions de bien vouloir joindre le numéro « BA » à toute commande de pièce de rechange ou demande d'information. Le numéro « BA » se situe sur un autocollant apposé sur le couvercle du coffre de toit.
- C.3 Afin de pouvoir obtenir une clé de rechange le plus rapidement possible en cas de perte ou de défectuosité, nous vous conseillons de noter le numéro de clé.
- C.4 Le coffre de toit ne doit pas être stocké à l'extérieur pour éviter d'être exposé aux éléments (comme la pluie ou la lumière directe du soleil).
- C.5 Le fabricant n'est pas responsable des dégâts et accidents provoqués par la non-observation du mode d'emploi, la modification des pièces ou l'utilisation d'autres pièces que les pièces d'origine du fabricant !

A.0 REGLAS DE SEGURIDAD

- A.1 Compruebe antes de y durante cada trayecto regularmente (en función del estado de la pista) si el cofre de techo está bien montado sobre las barras portaequipajes, la carga suficientemente asegurada, el cofre cerrado y la llave quitada.
- A.2 Asegúrese de que el cofre portaequipajes está cerrado y bloqueado, así como la llave fuera de la cerradura antes de comenzar la marcha.
- A.3 Si deja el cofre sin supervisión, compruebe todas las cerraduras, la carga y la sujeción para garantizar que se encuentra en correctas condiciones.
- A.4 ¡Una carga mal asegurada o unas barras portaequipajes y cofre incorrectamente fijados pueden soltarse durante el trayecto y ocasionar graves accidentes!
- A.5 Considere la altura modificada de su vehículo y los cambios en el comportamiento durante la conducción (sensibilidad al viento lateral, respuesta de frenado y en curvas) con el cofre y las barras portaequipajes montadas y, en particular, cargadas. En la parte exterior del cofre no deben amarrarse otras cargas.
- A.6 No debe sobrepasarse el peso total permitido del vehículo motorizado. Deben atenderse las instrucciones del fabricante del vehículo en relación a la carga máxima del techo:
- A.7 Cálculo de la carga de techo existente:
- $$\begin{aligned} & \text{Peso de las barras portaequipajes} \\ & + \text{Peso del cofre de techo} \\ & + \text{Peso de la carga} \\ & = \text{Carga del techo existente} \end{aligned}$$
- A.8 La velocidad del vehículo debe ajustarse siempre a la carga que se transporta y a las condiciones de conducción en cada momento como, por ejemplo, el tipo de carretera, el estado de la misma, el viento, la intensidad del tráfico y los límites de velocidad aplicables, aunque en ningún caso debe superar los 130 km/h. Siempre deben respetarse los límites de velocidad aplicables y las demás normativas de tráfico.
- A.9 El cofre de techo debe limpiarse y cuidarse esmeradamente, sobre todo durante los meses invernales. Utilice exclusivamente para ello una solución de agua y un detergente habitual en el comercio que no contenga alcohol, cloro o amoniaco, pues de lo contrario puede deteriorarse la superficie del cofre portaequipajes. No emplee ningún aerosol comercializado para la limpieza del cofre. Las cerraduras deben engrasarse con un lubricante pulverizado (el lubricante no debe entrar en contacto con la superficie de plástico).

B.0 POR FAVOR, TENGA EN CUENTA DURANTE EL USO DEL COFRE DE TECHO:

- B.1 La altura del vehículo puede aumentar hasta en 700 mm (en función de las barras soporte)
- B.2 Atención con las entradas bajas de garajes o puentes de escasa altura, ramas de árboles etc.
- B.3 Pueden producirse ruidos provocados por el viento.
- B.4 Para el uso de una instalación de lavado automático hay que quitar el cofre de techo y las barras portaequipajes.
- B.5 Además de las indicaciones de estas instrucciones de uso, tenga en cuenta asimismo las especificaciones en las instrucciones de montaje de las barras portaequipajes y el manual de servicio del vehículo.
- B.6 Por razones de ahorro de energía y de la seguridad en el tráfico vial, hay que desmontar el cofre de techo y las barras portaequipajes cuando no estén en uso.
- B.7 En aras a su propia seguridad, debería Vd. usar únicamente bacas o barras portaequipajes verificadas (p. ej. con homologación GS-TÜV) y permitidas para su vehículo.
- B.8 El cofre portaequipajes debe montarse con la parte delantera en la dirección de la marcha.
- B.9 Para evitar fuerzas ascensionales elevadas, hay que montar el cofre de techo sin ángulo de incidencia (paralelo en lo posible a la calzada).

- B.10 Si en las instrucciones no se indican posiciones de montaje especiales, se intentará mantener una distancia mínima de 700 mm entre las secciones del portaequipajes. Por favor, tenga en cuenta que no está permitida ninguna modificación del dispositivo de fijación del cofre de techo (p. ej. perforaciones adicionales).

C.0 MANTENIMIENTO

- C.1 Estas instrucciones de uso deberían guardarse y llevarse siempre con el manual de instrucciones del vehículo. ¡Cualquier modificación en los juegos de montaje y en el cofre, así como el uso de recambios y accesorios ajenos al fabricante, implican la anulación de la garantía y de la responsabilidad del fabricante por daños materiales o accidentes! Cumpla con exactitud estas instrucciones de uso y emplee únicamente las piezas originales suministradas. Si perdiera alguna pieza o sufriera desgaste, emplee sólo recambios originales, de adquisición en proveedores o directamente del fabricante.
- C.2 Para asegurar un rápido suministro de piezas de recambio y evitar pérdidas de tiempo, le pedimos especifique en todos sus pedidos de repuestos y consultas el „Núm. BA:“. Este „Núm. BA:“ se encuentra en un adhesivo situado en la parte superior del cofre de techo.
- C.3 Para que pueda Vd. solicitar rápidamente un repuesto en caso de una llave perdida o defectuosa, le recomendamos que anote el número de la llave.
- C.4 El cofre portaequipajes no debe guardarse en el exterior expuesto a los elementos (p. ej. lluvia o luz solar directa).
- C.5 El fabricante no se responsabiliza de daños y accidentes provocados por la no observancia de estas instrucciones de uso, la modificación de piezas o el uso de piezas distintas a las originales de recambio del fabricante.

A.0 REGULAMENTOS DE SEGURANÇA DA GRÃBRETANHA

- A.1 Verifique em intervalos regulares (dependendo das condições da estrada) antes e durante cada viagem, se o bagageiro de teto está firmemente fixado no rack, se a carga está presa de forma adequada, se o bagageiro está trancado e a chave foi retirada da fechadura.
- A.2 Certifique-se de que o bagageiro de teto esteja fechado e trancado e que a chave seja removida da trava antes de começar a dirigir.
- A.3 Se deixado sem supervisão, verifique todas as travas, a carga e a fixação do bagageiro para garantir que tudo esteja nas condições corretas.
- A.4 Cargas mal presas e racks e bagageiros de teto montados de forma incorreta podem se soltar durante a viagem, causando graves acidentes!
- A.5 Leve em consideração o aumento na altura do veículo e a alteração em seu comportamento ao rodar (sensibilidade a ventos laterais, comportamento nas curvas e nas frenagens) com o rack e/ou bagageiro de teto montado(s) e carregado(s). Cargas adicionais não devem ser acondicionadas fora do bagageiro de teto.
- A.6 O peso total permitido para o veículo não pode ser ultrapassado. Devem ser observadas as instruções do fabricante do veículo sobre o peso máximo da carga que pode ser transportada no teto.
- A.7 Cálculo do peso disponível para carga a ser transportada no teto:
- Peso do rack de teto
 - + peso do bagageiro
 - + peso da carga
 - = peso disponível para a carga a ser transportada no teto
- A.8 A velocidade do veículo deverá ser sempre ajustada à carga sendo transportada e às condições de direção atuais, como tipo e qualidade do pavimento, condições de vento, intensidade do tráfego e limites de velocidade aplicáveis. No entanto, em nenhuma circunstância ela deverá exceder 130 km/h. Os limites de velocidade aplicáveis e outras normas de tráfego devem ser sempre observados.
- A.9 O bagageiro de teto deve ser cuidadosamente limpo e conservado, em particular durante os meses de inverno. Para esse propósito, use apenas uma solução de água e detergente sem aditivos à base de álcool, alvejante ou amônia, caso contrário a superfície do bagageiro pode ser danificada. Não use silicone em aerossol para limpar o bagageiro de teto. As travas devem ser lubrificadas com lubrificante em aerossol (a superfície plástica do bagageiro não deve entrar em contato com nenhum tipo de lubrificante).

B.0 OBSERVE OS SEGUINTE PONTOS AO USAR O BAGAGEIRO DE TETO:

- B.1 A altura do veículo poderá aumentar em até 700 mm (dependendo do modelo de rack de teto usado)
- B.2 Esteja atento para garagens com entradas baixas, qualquer local com pouca altura livre, galhos de árvores baixos, etc.
- B.3 Pode ocorrer ruído de vento nas janelas.
- B.4 O bagageiro e o rack de teto devem ser removidos antes de usar lava rápidos automáticos.
- B.5 Além destas instruções de uso, deve-se prestar atenção às instruções de montagem do rack de teto e às instruções de operação do veículo.
- B.6 Para economizar combustível e para a segurança dos demais motoristas, o bagageiro e o rack de teto devem ser removidos quando não estiverem sendo usados.
- B.7 Para sua própria segurança, devem ser usados apenas racks de teto testados (teste GS, por exemplo) e autorizados para uso em seu veículo.
- B.8 O bagageiro de teto deve ser montado com a frente voltada para a direção do deslocamento.

- B.9 Para evitar a geração de forças de sustentação excessivas, os bagageiros de teto devem ser montados paralelos ao eixo da estrada e não em ângulo.
- B.10 Siga os detalhes nas instruções de montagem. Na maioria das vezes, as instruções especificam a distância entre as Barras do Rack. Se nenhuma instrução específica for recomendada, tente manter uma distância mínima de 700mm entre as Barras do Rack. Não são permitidas alterações no sistema de fixação do bagageiro de teto (furação adicional, por exemplo).

C.0 MANUTENÇÃO

- C.1 Estas instruções de uso devem ser mantidas juntas com as instruções de operação do veículo e estar disponíveis sempre que o equipamento estiver em uso e na estrada. Quaisquer alterações feitas nos conjuntos de montagem e no bagageiro de teto, assim como o uso de peças de reposição ou acessórios outros que não aqueles fornecidos pelo fabricante causarão a perda de validade da garantia e da responsabilidade do fabricante por qualquer dano ou acidentes que venham a ocorrer. Deve-se então observar estritamente estas instruções de uso e instalar apenas as peças originais fornecidas. No evento de perda ou desgaste de peças, elas devem ser repostas ou substituídas por peças de reposição originais que podem ser adquiridas de um fornecedor especializado ou do fabricante.
- C.2 Para assegurar o rápido fornecimento de peças de reposição, evitando perder tempo com pesquisas, pedimos que seja indicado o "Nº de BA" sempre que se fizer um pedido de peças de reposição ou se tiver alguma dúvida. O "Nº de BA" pode ser encontrado em uma etiqueta adesiva localizada na tampa do bagageiro de teto.
- C.3 Para assegurar-se de sempre poder substituir qualquer chave perdida ou com defeito o mais rapidamente possível, aconselhamos anotar os números das chaves.
- C.4 O bagageiro de teto não deve ser armazenado ao ar livre exposto aos elementos (por exemplo, chuva ou luz solar direta).
- C.5 O fabricante não é responsável por nenhum dano ou acidente que possa ocorrer como resultado da não obediência a estas instruções de uso, de alterações feitas no equipamento ou do uso de quaisquer peças que não sejam originais.

Thule Inc. 42 Silvermine Road, Seymour, CT 06483
Thule Canada Inc. 710 Bernard, Granby QC J2J 0H6
North American Consumer Service:
Toll Free 800-238-2388, Fax 450-777-3615
www.thule.com

Register online at:
www.thule.com/register

© Thule Group. All rights reserved.
5563823001 | 2024-10-30 #00