

Kit 1572

VW Transporter T4, 4-dr Van, 91-96, 97-02

VW Eurovan, 4-dr Van, *92-03

*North America

480R
754

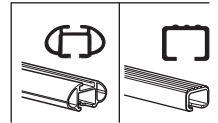
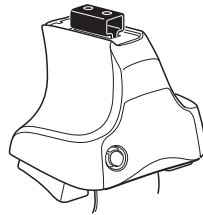

480

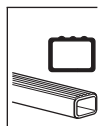
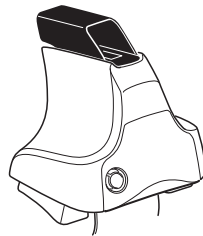

THULE[®]
SWEDEN

ISO 11154-E

Max.
50 kg/110 lbs

Max.
100 kg/220 lbs

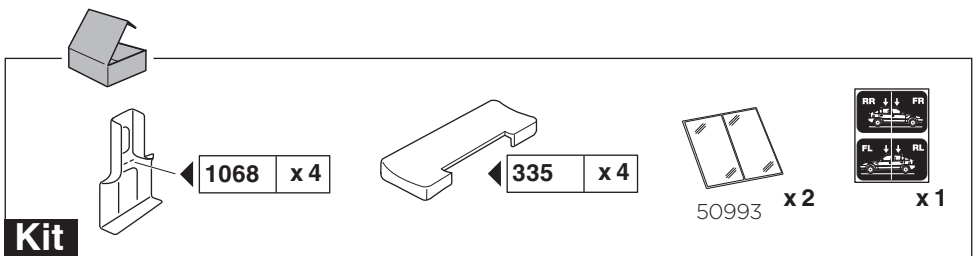
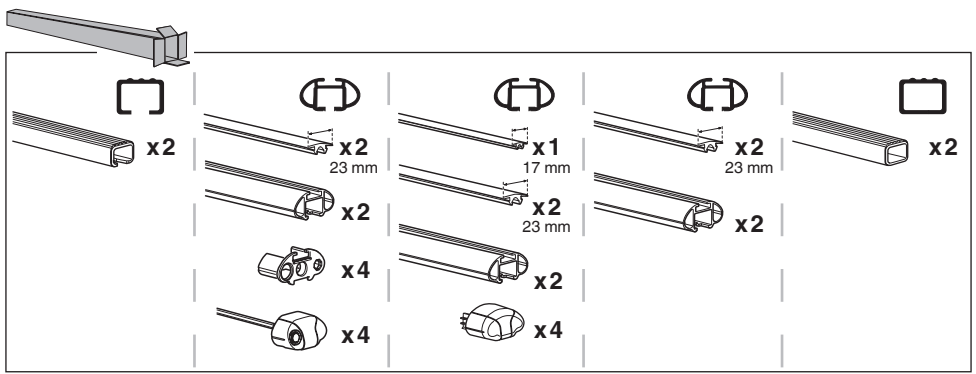
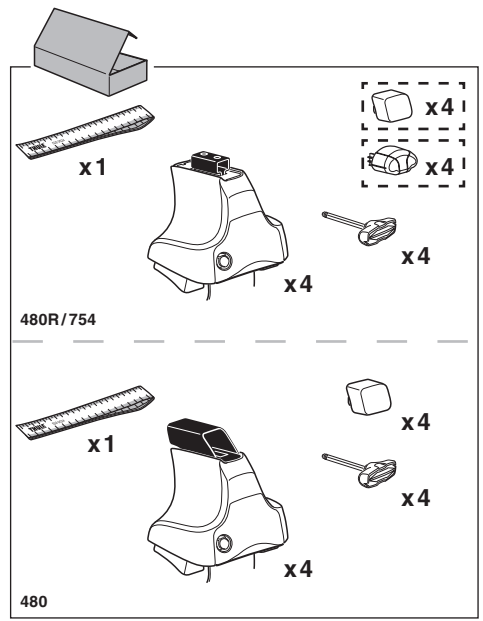
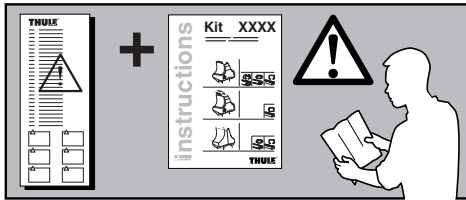
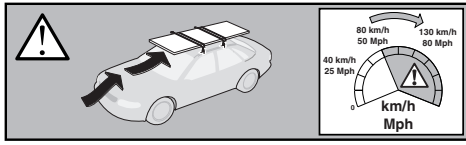
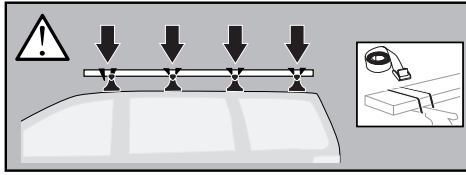

1

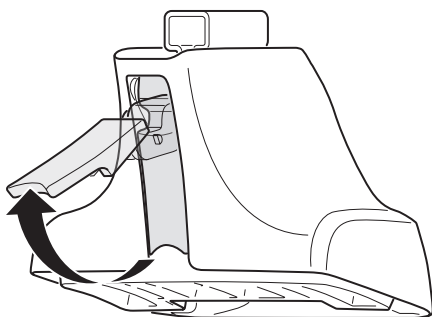
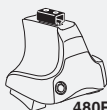

2



+

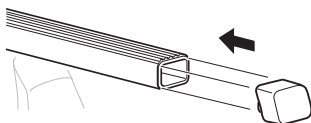
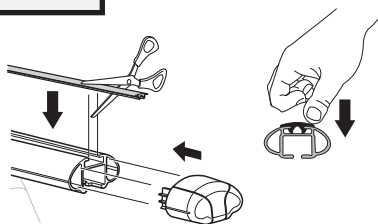
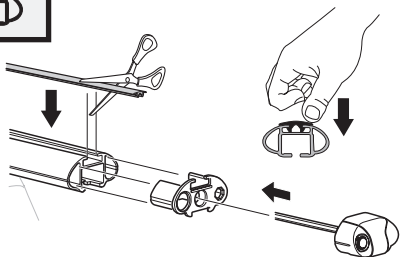
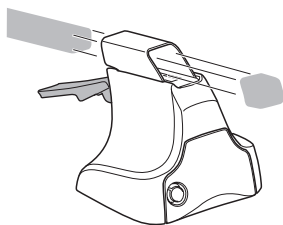
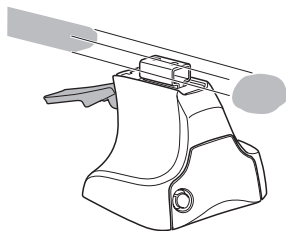

3

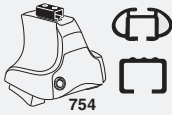

754

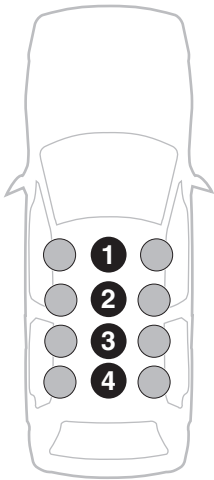

A

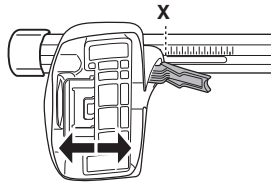

B

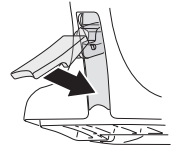

	X
1	59.5
2	59
3	57.5
4	54.5



480R



480



A

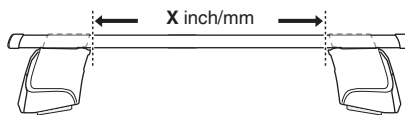

B

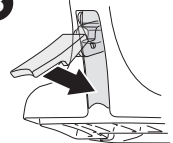

	X inch	X mm
1	49"	1246 mm
2	48 ⁷ / ₈ "	1241 mm
3	48 ¹ / ₄ "	1226 mm
4	47 ¹ / ₈ "	1196 mm

4



480R/754



480



1068 x 4

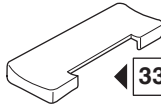

335 x 4



x 1

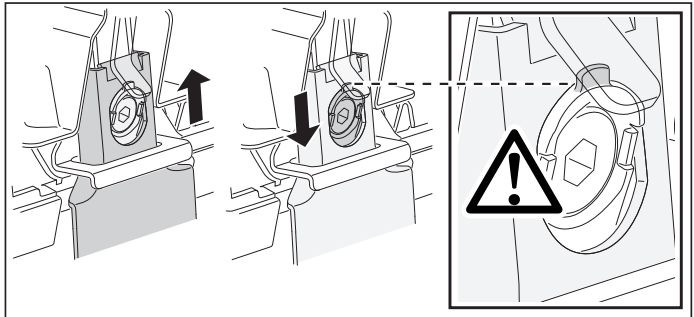
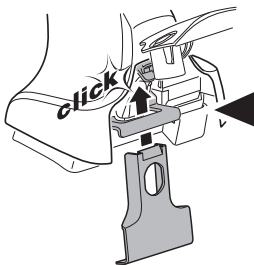
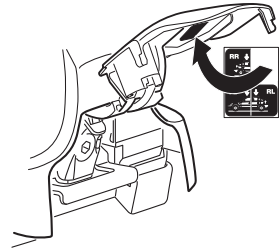
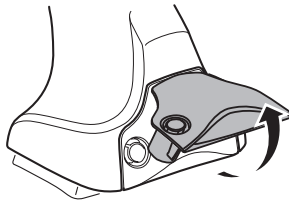
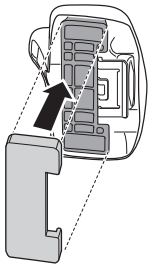

5

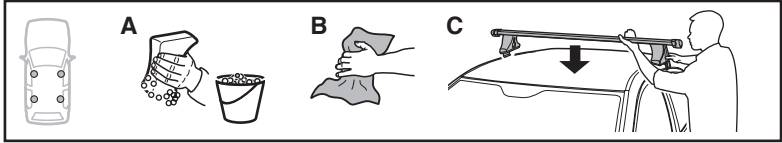

	inch	mm
A	11 ³ / ₄ "	300 mm
B	39 ³ / ₈ "	1000 mm
C	66 ⁷ / ₈ "	1700 mm
D	94 ¹ / ₂ "	2400 mm

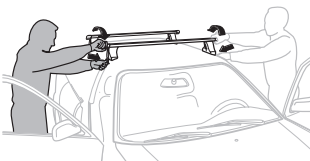
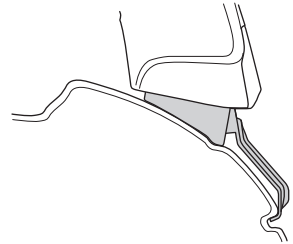
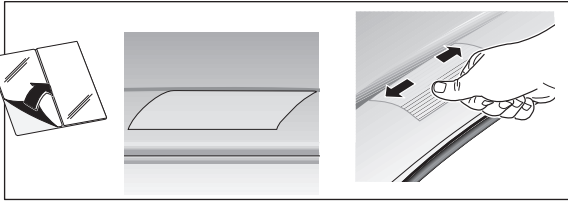
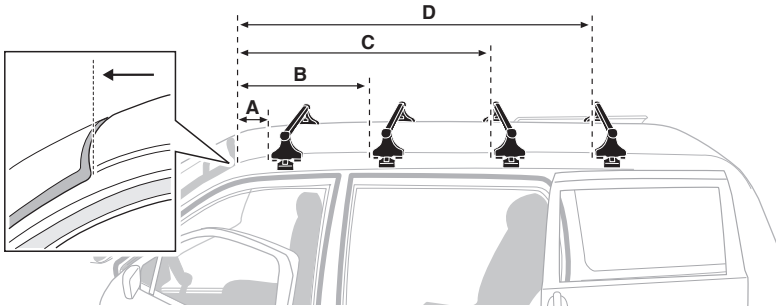

- GB/US** Tighten alternately
D Die Schrauben abwechselnd anziehen
F Serrer alternativement chaque côté
NL Afwisselend aan de linker- en de rechterkant aandraaien
I Alternare il serraggio delle viti
E Apretar alternativamente
PT Aperte alternadamente
S Dra åt växelvis
FIN Kierrä vuorotellen
EST Pinguldage vaheldumisi
LAT Pievelciēt pamišus
LIT Užsukinėkite pakaitomis
PL Śruby dokręcaj naprzemiennie
RU Затягивайте попеременно

- CZ** Pokrétla bagožníka dokręcaj dokręcaj naprzemiennie.
SK Dotahujte striedavo
SLO Privijajte izmenično.
HR Naizmjenično zategnite
HU Egyarástól függetlenül szorítandó
GR Σφιγίγστε εναλλάξ
TR Dönüşümlü sıkın

中文 交替拧紧

한국어 번갈아 가며 조이십시오.

日本語 交互に締め付けてください。

ไทย ขันโน้แบบบสลับ

6

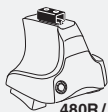

480R/754



480

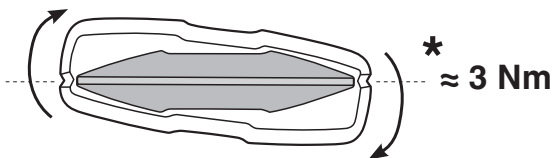
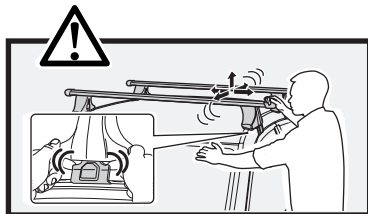
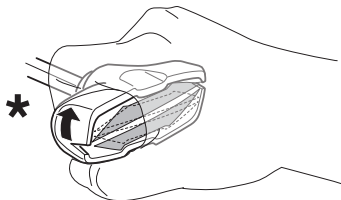
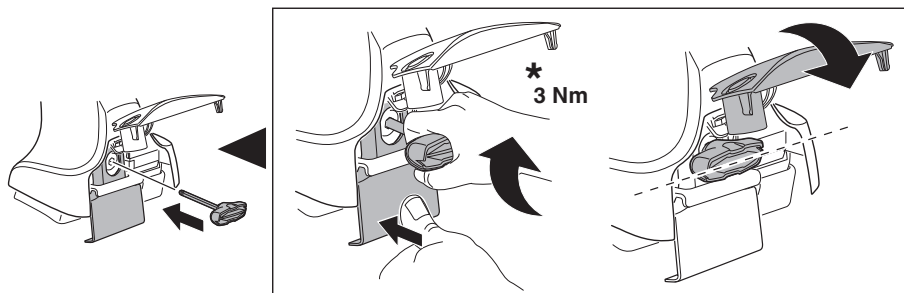

7

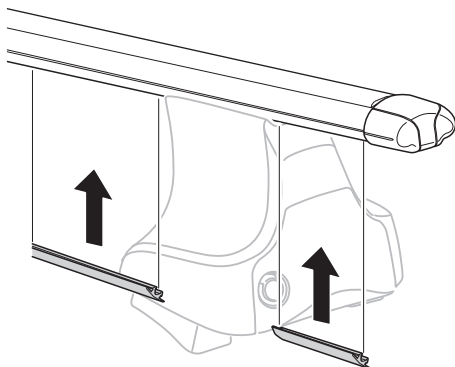
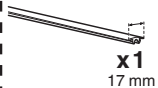

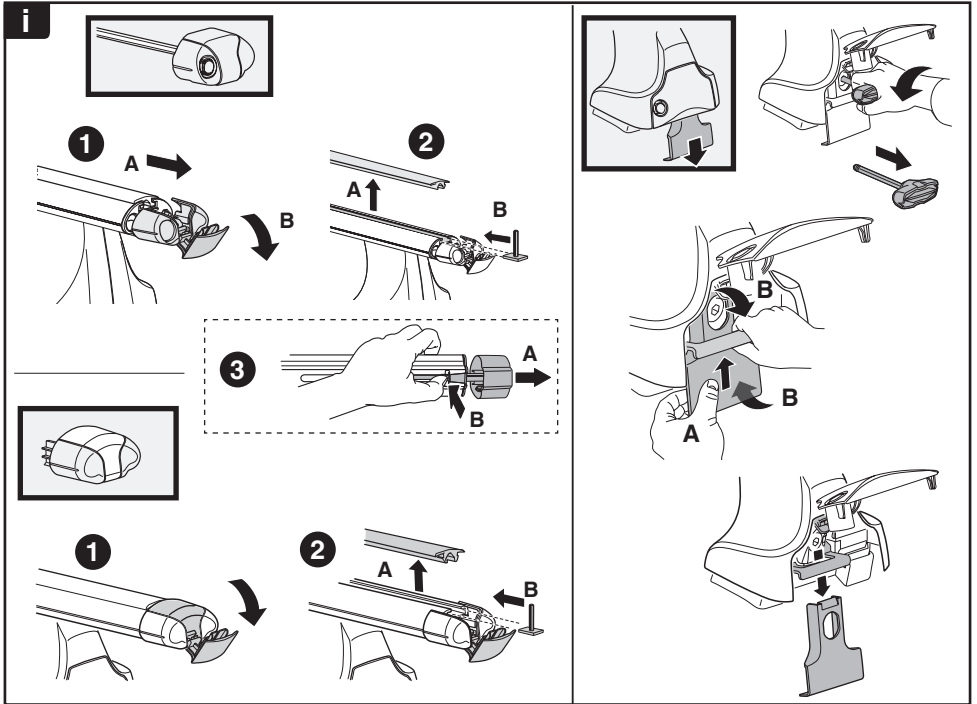
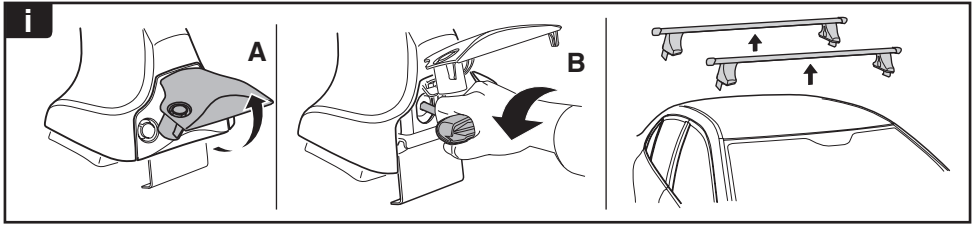

THULE
SWEDEN

**ONE
KEY
SYSTEM**

544 (x4)

596 (x6)

588 (x8)

NA **510** (x10)



EUR **452** (x12)



ASIA

WW ▶ Thule Sweden AB, Box 69, 330 33 Hillerstorp, SWEDEN
 NA ▶ Thule Inc., 42 Silvermine Road, Seymour, Connecticut 06483, USA

info@thule.com
 customer.service@thule.com

www.thule.com

 www.thuleprofessional.com
 customer.service@thule.com
 info@thule.com

 **NA**
 Thule Inc., 42 Silvermine Road, Seymour, Connecticut 06483, USA
 **SE**
 Thule Sweden AB, Box 69, 330 33 Hillerstorp, SWEDEN

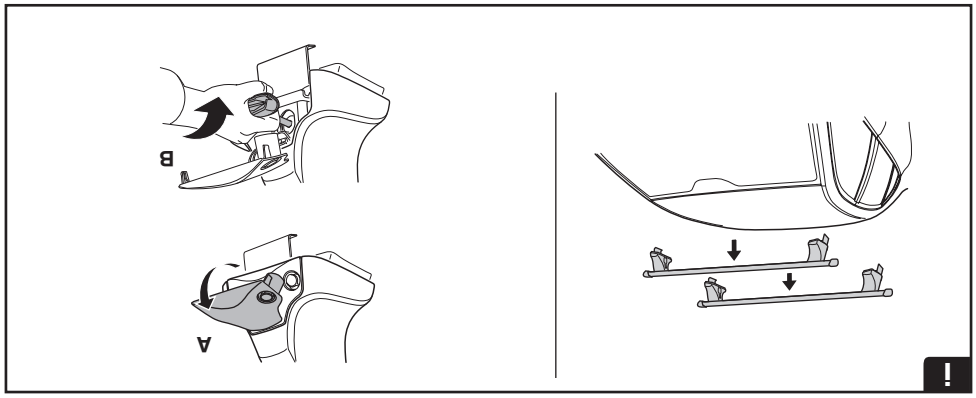
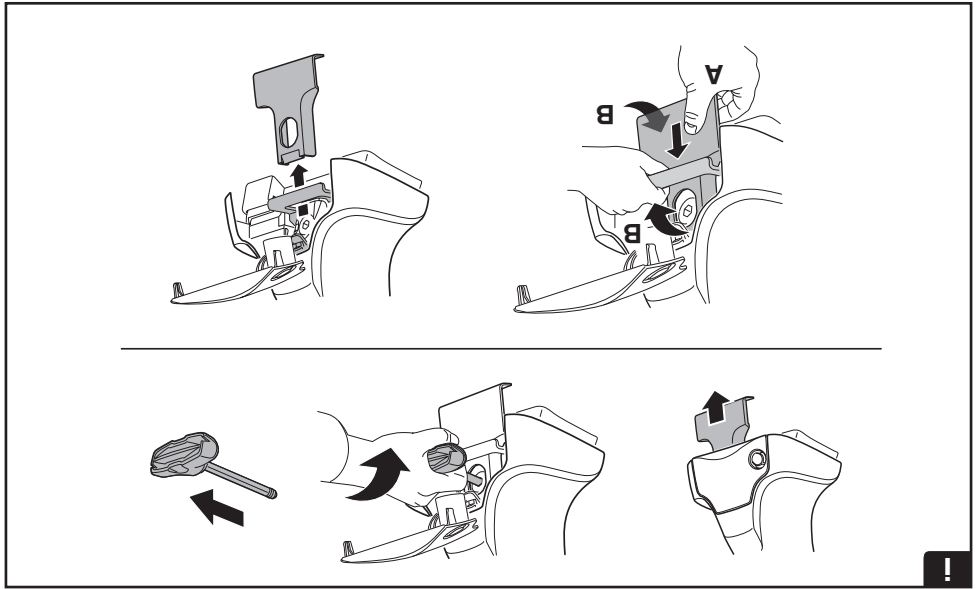

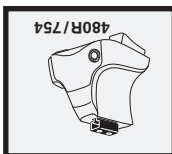
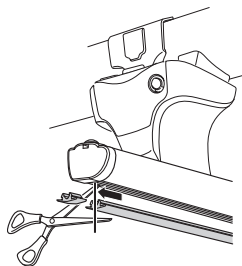
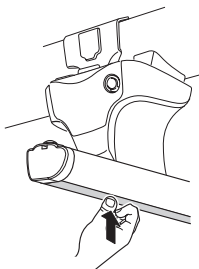
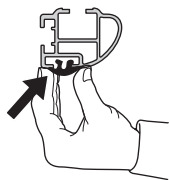

8

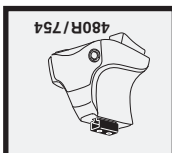
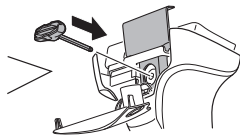
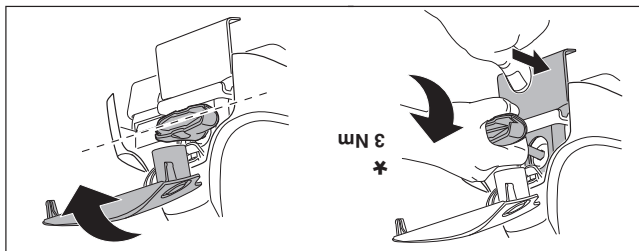
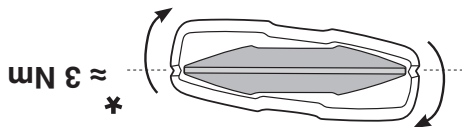
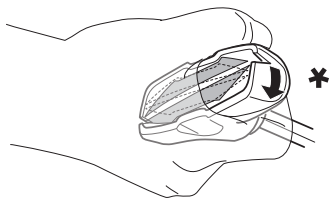
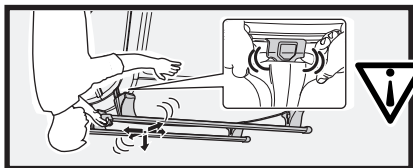

7

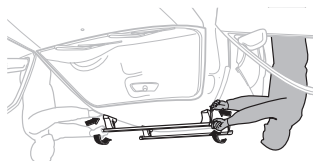

GB/US Tighten alternately
 D Die Schrauben abwechselnd
 F anziehen
 NL Aftersierend aan de linker- en de
 I rechterkant aandraaien
 E Alternare il serraggio delle viti
 PT Aperte alternadamente
 S Dra åt växelsvis
 FIN Kierä vuorotellen
 LAT Pnguldage vaheldumisi
 LT Užskinėkite pakaitomis
 PL Sruby dokrecaj naprzemiennie
 RU Затягивайте попеременно

CZ Počkejte bagazníka dokrecaj
 SK dokrecaj naprzemiennie.
 SLO Privijajte izmenično.
 HU Naizmjenično zategnite.
 HR Egymástól fűggetlenül
 GR szorítandó
 TR Dönüşümlü sıkın
 日本語 交互に締め付けてください。
 中文 交替拧紧

日本語 交互に締め付けてください。
 中文 交替拧紧

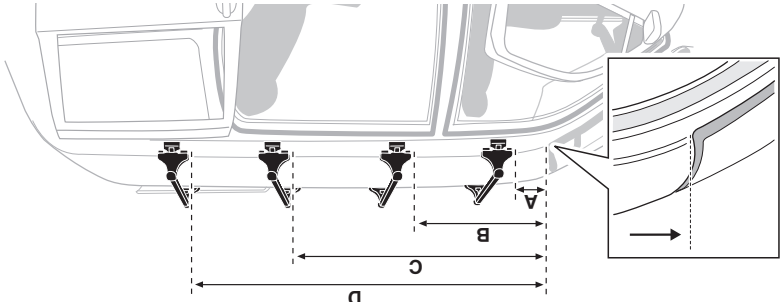
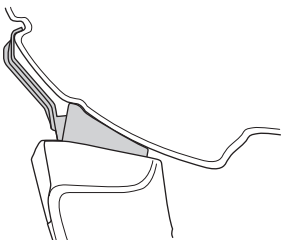
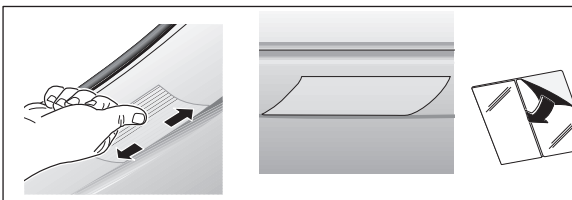

D	94 1/2"	2400 mm
C	66 7/8"	1700 mm
B	39 3/8"	1000 mm
A	11 3/4"	300 mm

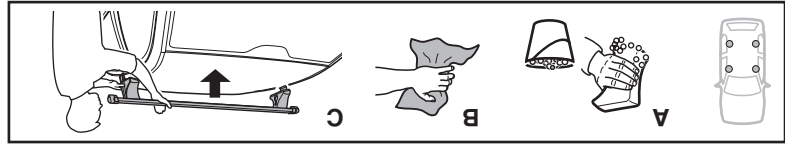

6

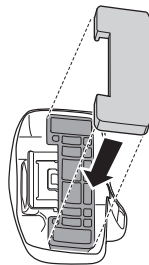
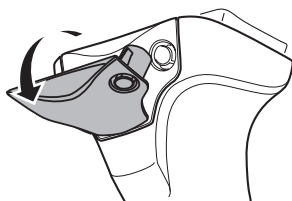
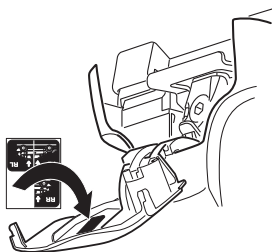
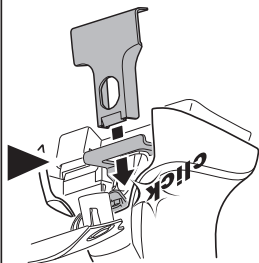
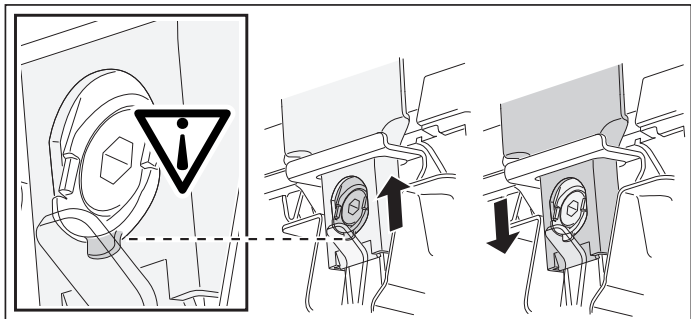

X 1



X 4

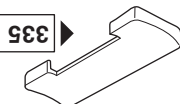

X 4

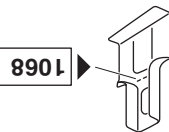

480R/754



5

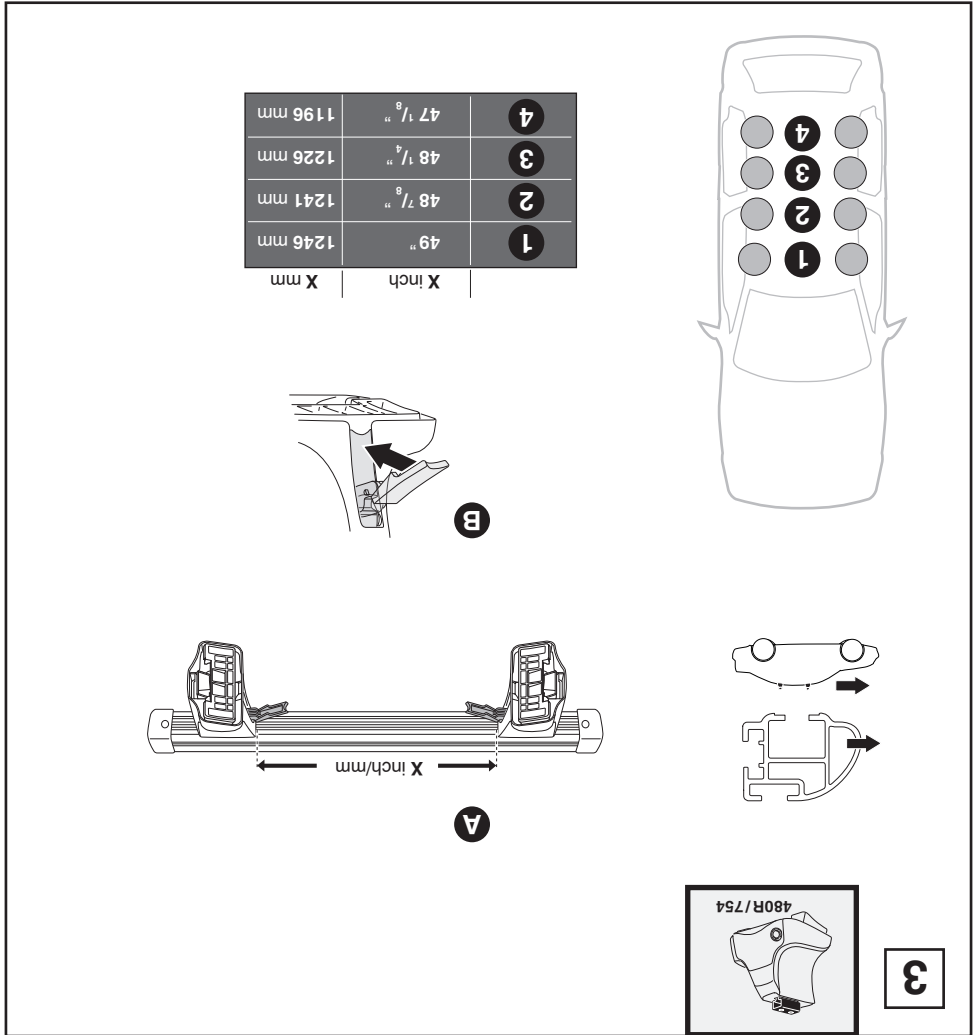
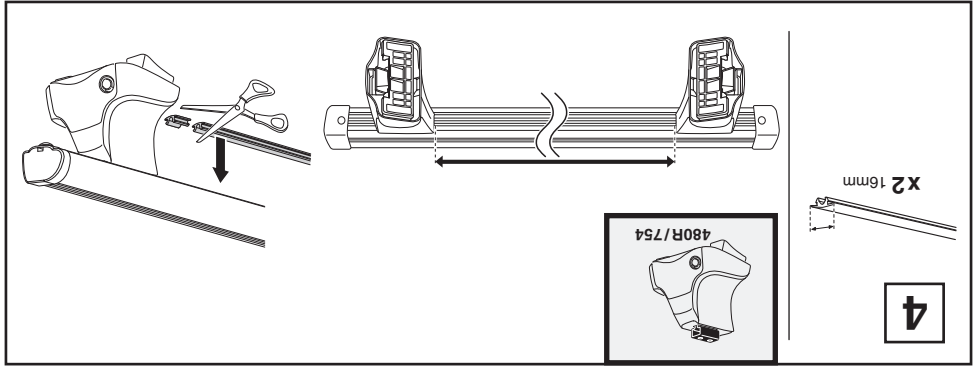

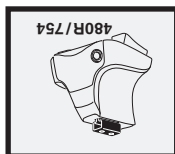
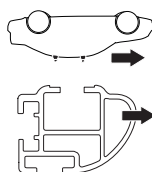
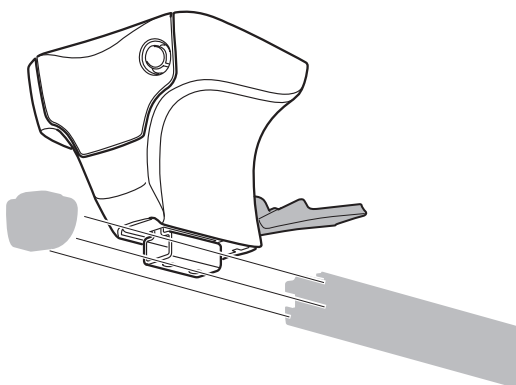
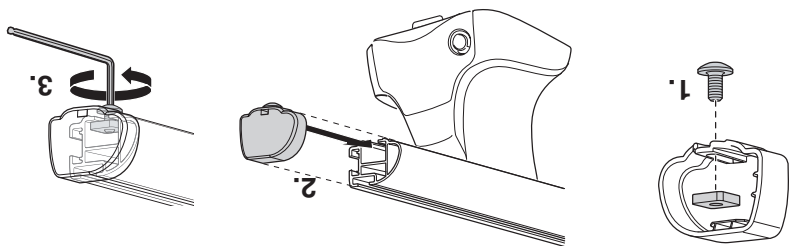

2

-  X1 5mm
-  X4
-  X4
-  X2
-  X2

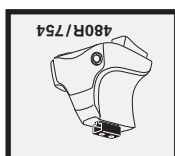
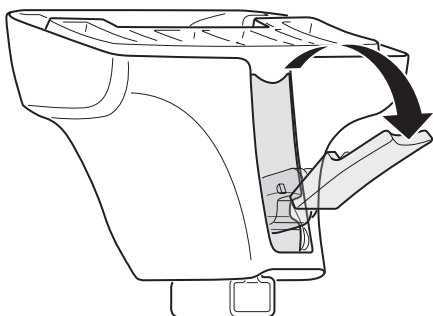

1

Kit

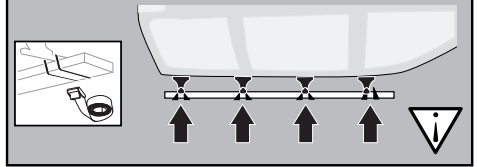
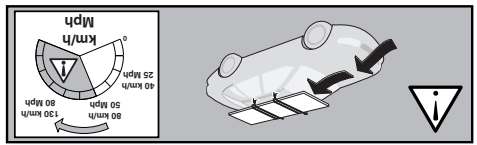
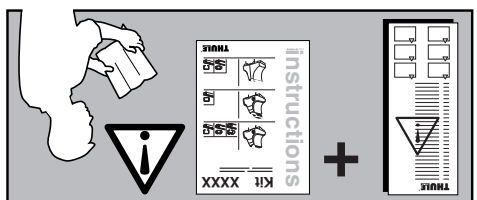
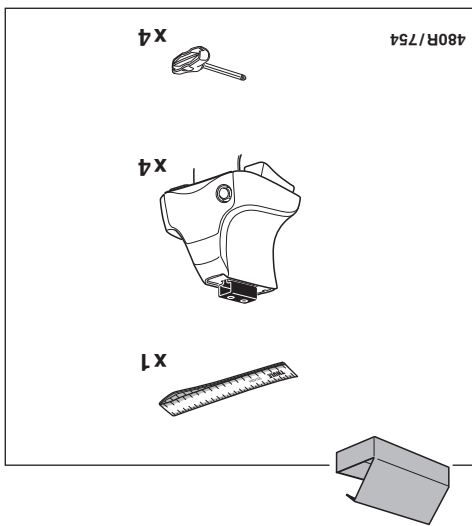
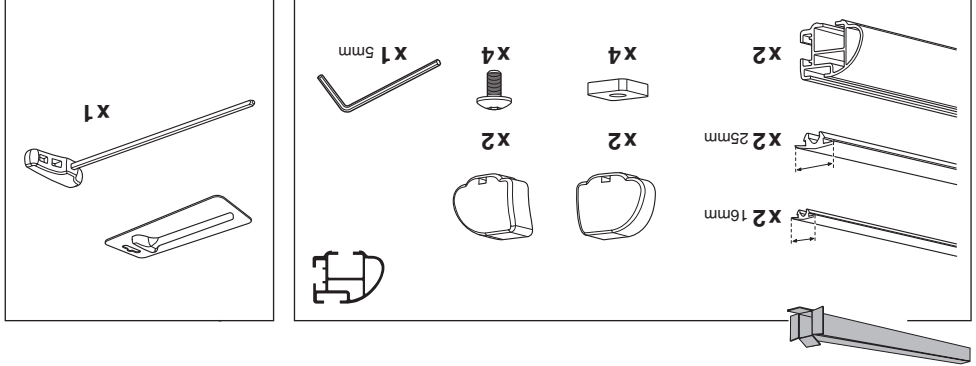
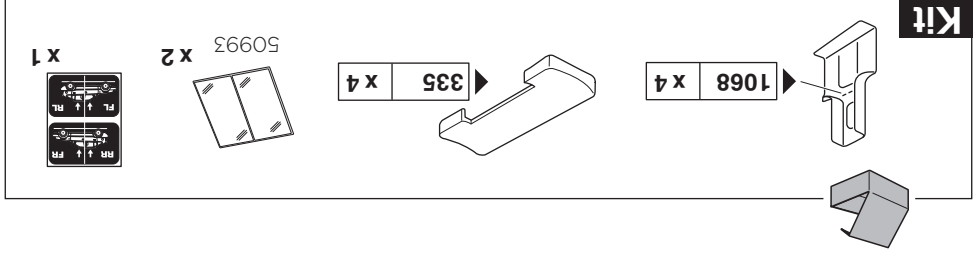

instructions

Kit 1572

VW Transporter T4, 4-dr Van, 91-96, 97-02
VW Eurovan, 4-dr Van, *92-03
*North America

480R
754

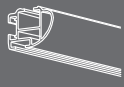
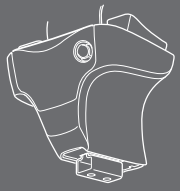

ISO 11154-E

PROFESSIONAL
THULE
SWEDEN®