



## Thule XT Kit 3068

# > Instructions

**HYUNDAI Accent**, 5-dr Hatchback, 12-17 /\*\*12-19

**HYUNDAI i20 (Mk.II.)**, 5-dr Hatchback, 15-20

**HYUNDAI i25**, 5-dr Hatchback, 12-

**HYUNDAI Solaris**, 5-dr Hatchback, 12-

**HYUNDAI Verna**, 5-dr Hatchback, 12-

**SUBARU Impreza (Mk.III.)**, 4-dr Sedan, 07-11

**SUBARU Impreza (Mk.III./IV)**, 5-dr Hatchback, 07-11, 12-16

**SUBARU Impreza / WRX**, 4-dr Sedan, \*08-11

**SUBARU Impreza / STI / WRX**, 5-dr Hatchback, \*08-11, 12-16

**SUBARU XV**, 5-dr SUV, 12-17

\*North America

\*\*Australia

**This kit is only for vehicles with fixpoint mounting.**

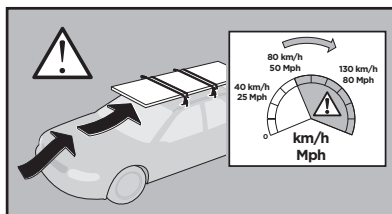
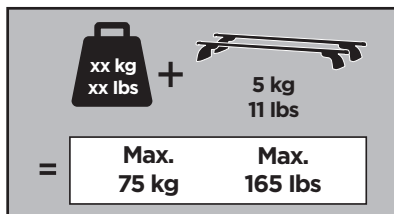
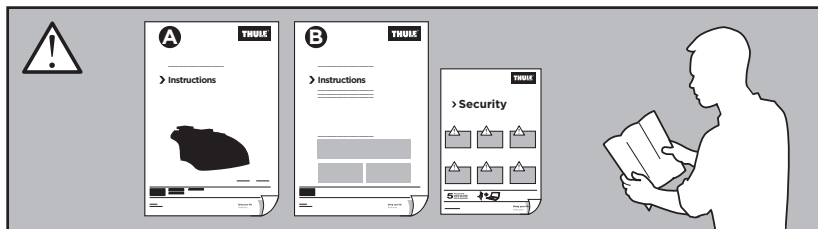

ISO 11154-E

183068

C.20210317  
5561251001

Bring your life

thule.com

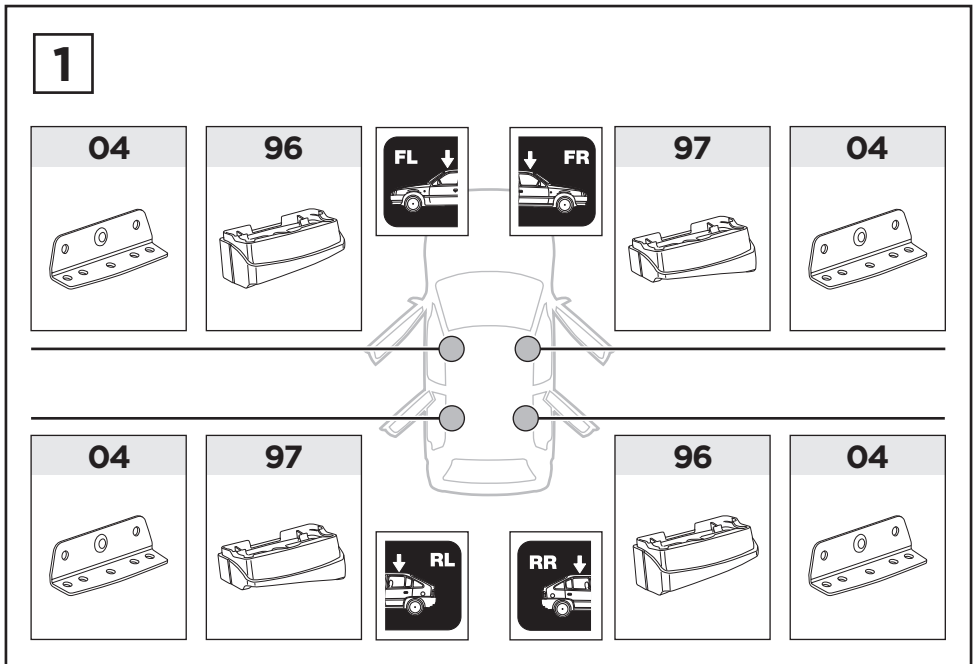
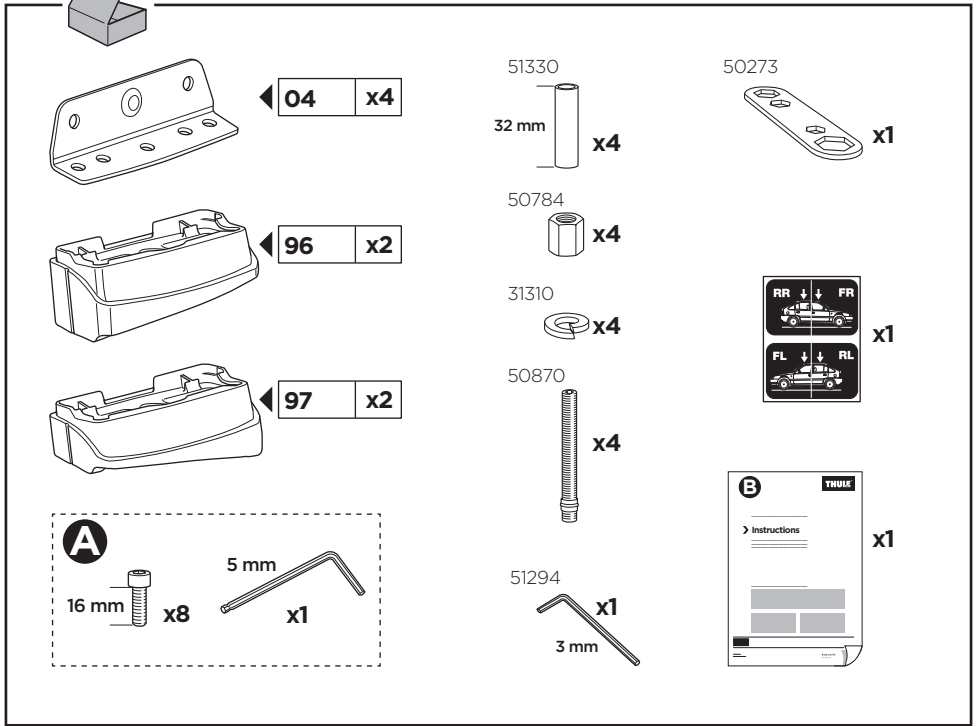

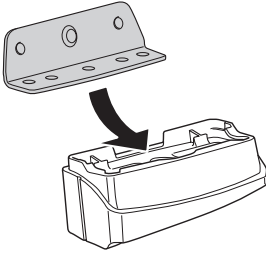
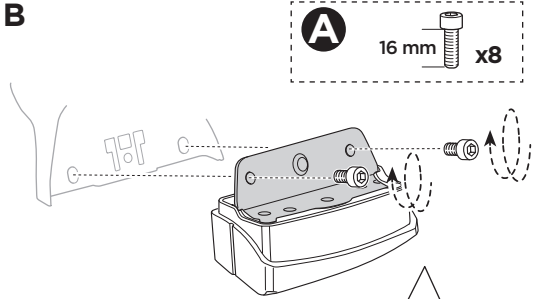
**2****A****B**

- EN** Only a few turns  
**DE** Nur wenige Umdrehungen  
**FR** Quelques tours uniquement  
**NL** Slechts enkele slagen  
**IT** Solo qualche giro  
**ES** Sólo algunas vueltas  
**PT** Noções básicas  
**SV** Endast några varv  
**DK** Kun nogle få omgange  
**NE** Bare noen få omdreinger  
**FI** Vain muutama kierros  
**ET** Ainult mõni pööre  
**LV** Tikai dažī apgriezieni  
**LT** Tik keli pasukimai  
**PL** Wystarczy kilka obrotów  
**RU** Только несколько оборотов

- UK** Лише декілька обертів  
**BG** Само няколко завъртания  
**CS** Pouze několik otáček  
**SK** Len niekoľko otáčok  
**SL** Le nekaj obratov  
**HR/BiH** Samo nekoliko okreta  
**RO** Doar câteva rotiri  
**HU** Csak néhány fordítás  
**EL** Μόνο λίγες περιστροφές  
**TR** Yalnızca birkaç tur

بعض دورات فقط

**AR**

רק מספר סיבובים

**HE**

- ZH** 仅几圈  
**JA** 2～3回転のみ  
**KO** 몇 번만 돌리면 됨  
**TH** เพียงสองสามรอบ

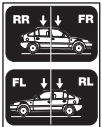
**3**

x1

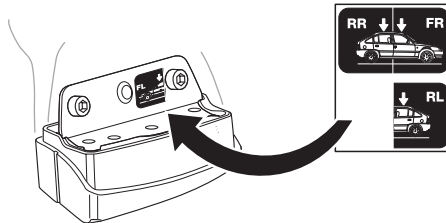

**4**

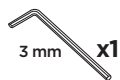

**A**

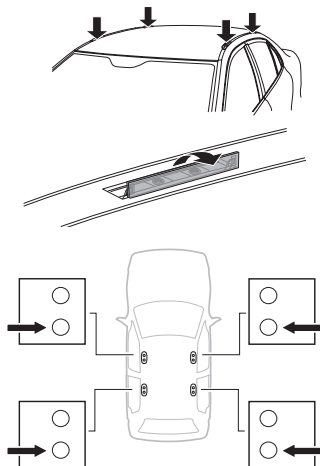

**B**

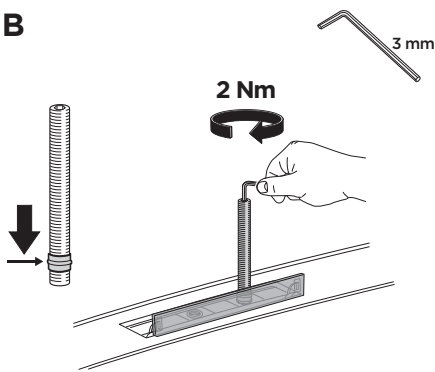

**D**

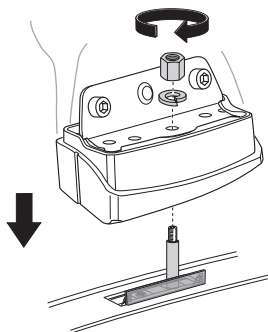

**C**

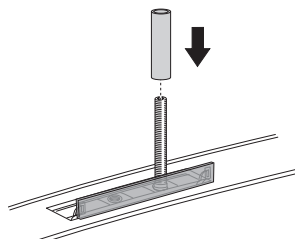

**5**

**A**

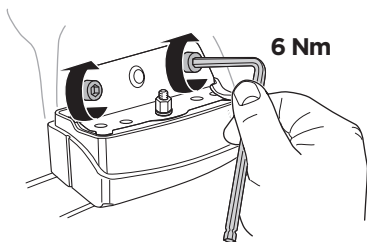
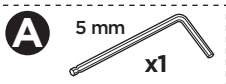

**B**

