



Thule XT Kit 3175

> Instructions

CITROËN Berlingo, 4-dr Van, 19-
OPEL Combo, 4-dr Van, 19-
OPEL Combo Life, 5-dr MPV, 19-
PEUGEOT Partner, 4-dr Van, 19-
TOYOTA Proace City, 4-dr Van, 20-
VAUXHALL Combo, 4-dr Van, 19-
VAUXHALL Combo Life, 5-dr MPV, 19-

This kit is only for vehicles with fixpoint mounting.

The diagram illustrates the components and usage of the Thule XT Kit 3175. On the left, it shows the contents: two FootPacks (751 and 753) and a Security bag. In the center, two weight limit calculations are shown: $xx \text{ kg} / xx \text{ lbs} + 6 \text{ kg} / 13 \text{ lbs} = \text{Max. } 100 \text{ kg} / 220 \text{ lbs}$ and $xx \text{ kg} / xx \text{ lbs} + 9 \text{ kg} / 20 \text{ lbs} = \text{Max. } 150 \text{ kg} / 330 \text{ lbs}$. On the right, two diagrams show the kit being mounted on a vehicle roof rack and a speedometer indicating a maximum speed of 80 km/h (50 Mph) for the 100 kg limit and 130 km/h (80 Mph) for the 150 kg limit.

ISO 11154-E

183175

C.20200610
5560249001

Bring your life
thule.com

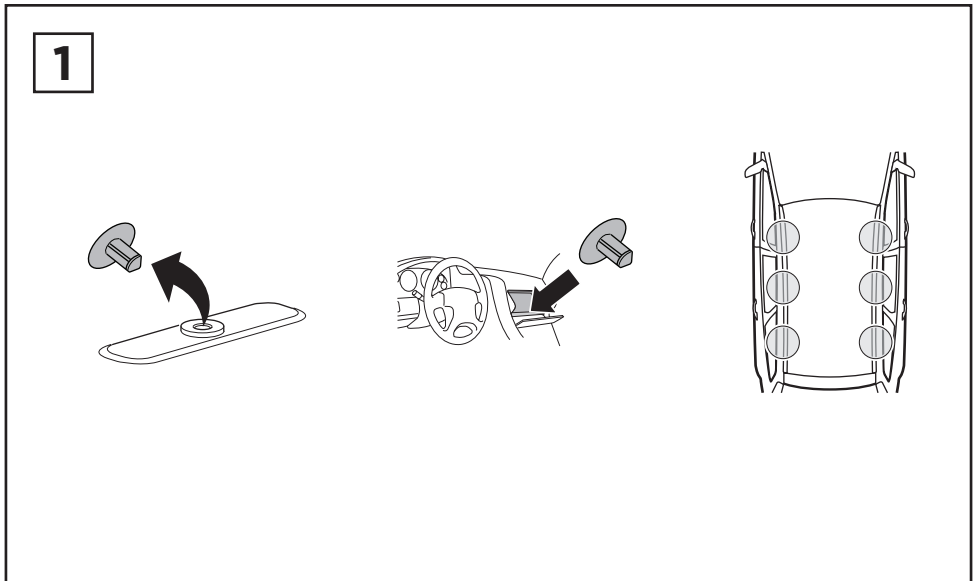
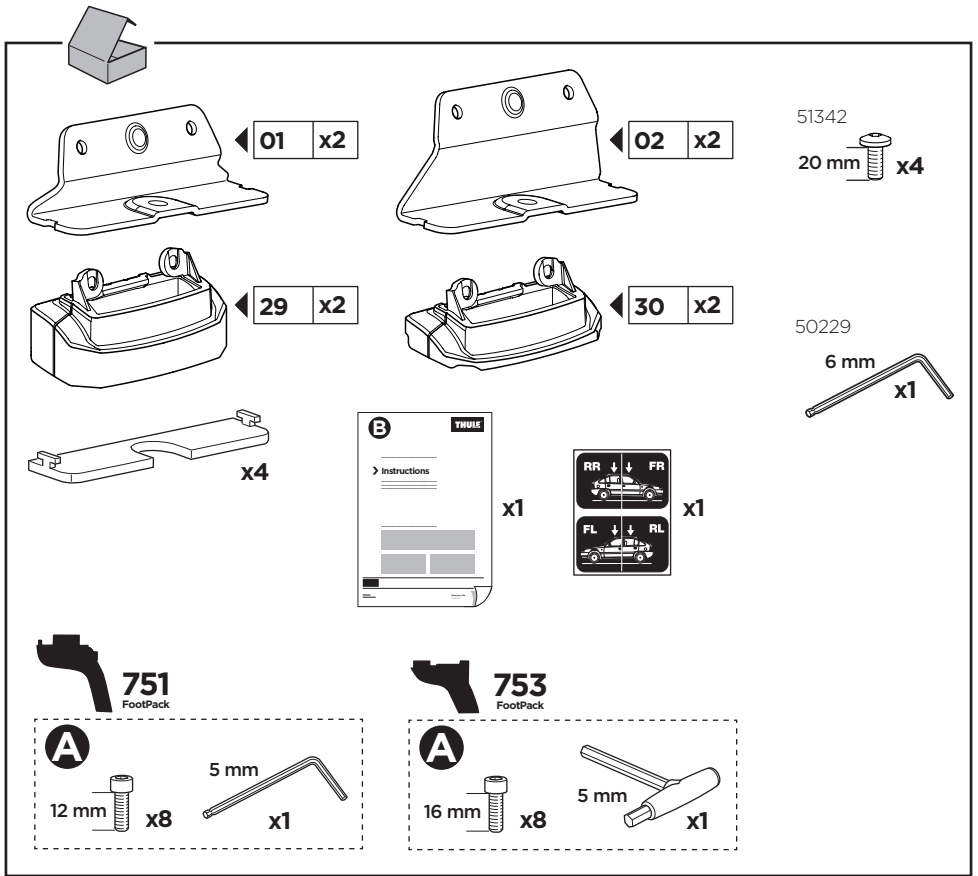

2

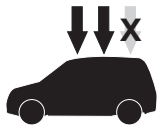
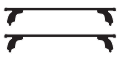

753 FootPack

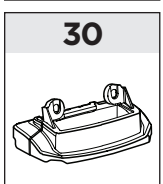
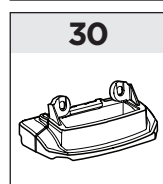
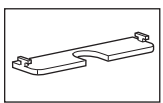
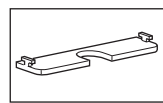
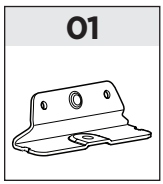
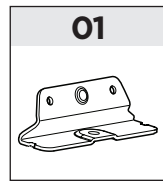
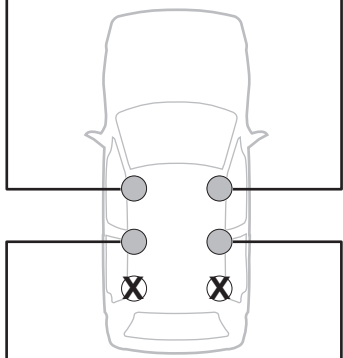
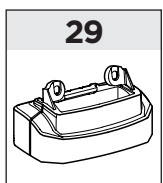
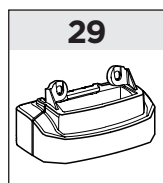
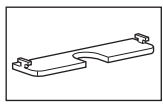
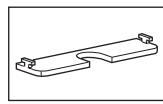
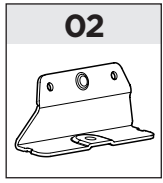
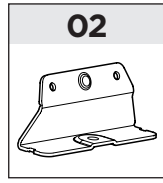

2

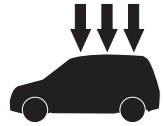

751 FootPack

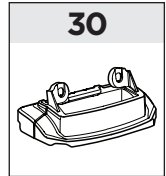
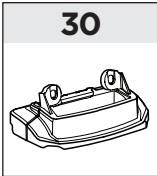
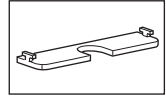
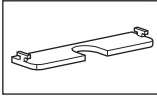
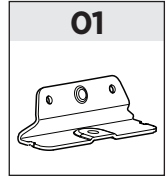
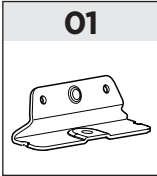

753 FootPack

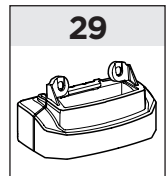
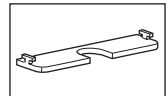
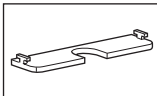
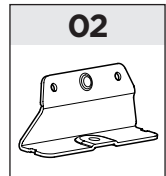
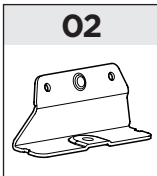

3 753 FootPack

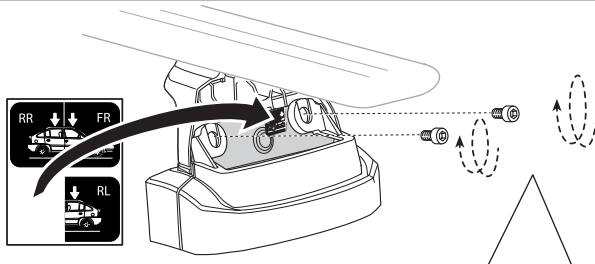
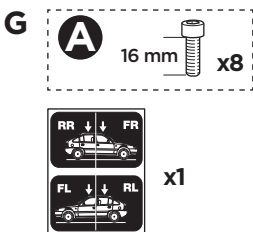
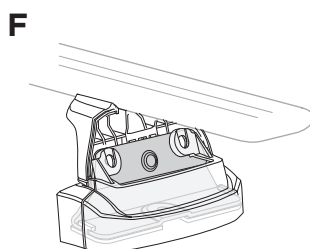
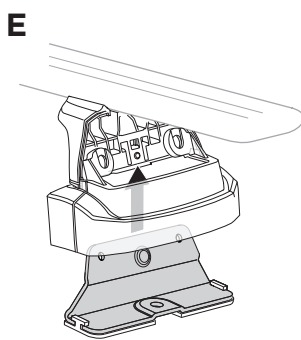
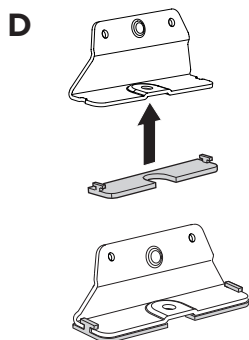
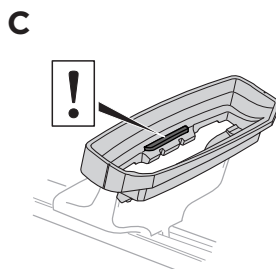
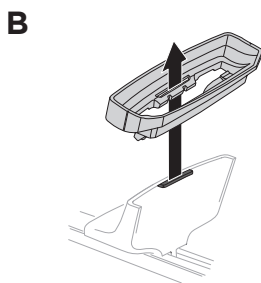
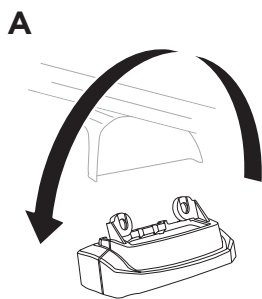

EN Only a few turns
DE Nur wenige Umdrehungen
FR Quelques tours uniquement
NL Slechts enkele slagen
IT Solo qualche giro
ES Sólo algunas vueltas
PT Noções básicas
SV Endast några varv
DK Kun nogle få omgange
NE Bare noen få omdreinger
FI Vain muutama kierros

ET Ainult mõni pööre
LV Tikai dažī apgriezieni
LT Tik keli pasukimai
PL Wystarczy kilka obrotów
RU Только несколько оборотов
UK Лише декілька обертів
BG Само няколко завъртания
CS Pouze několik otáček
SK Len niekoľko otáčok
SL Le nekaj obratov
HR/BIH Samo nekoliko okreta

RO Doar câteva rotiri
HU Csak néhány fordítás
EL Μόνο λίγες περιστροφές
TR Yalnızca birkaç tur
ZH 仅几圈
JA 2 ~ 3 回転のみ
KO 몇 번만 돌리면 됨
TH เพียงสองสามรอบ

AR بعض دورات فقط
HE רק מספר סיבובים

3



751
FootPack

A

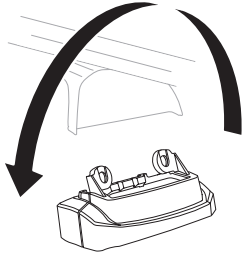

B

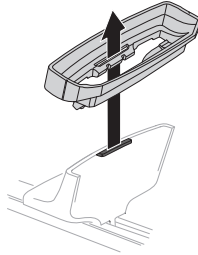

C

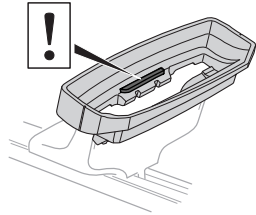

D

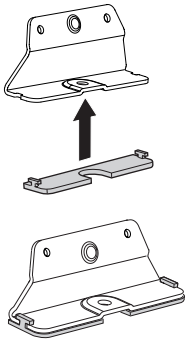

E

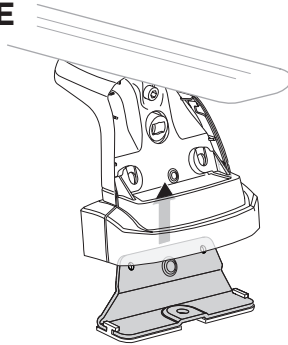

F

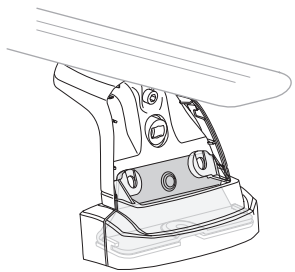

G

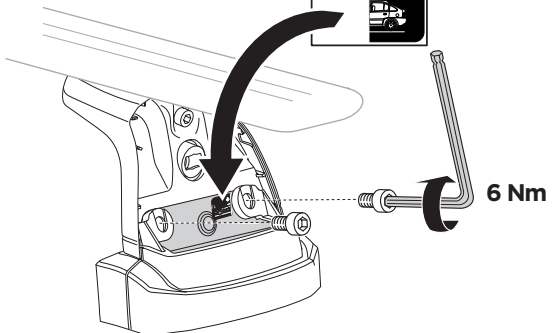
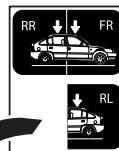
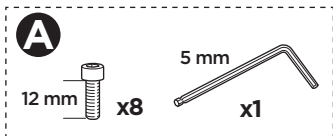

4

753
FootPack

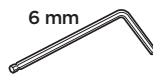
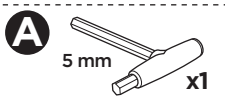

A

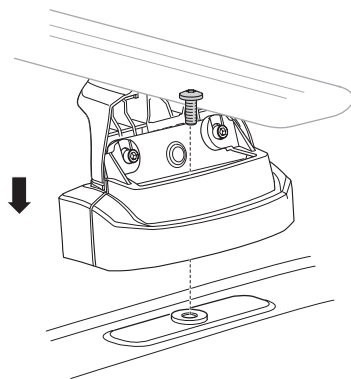

B

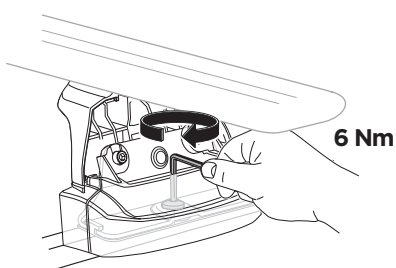

C

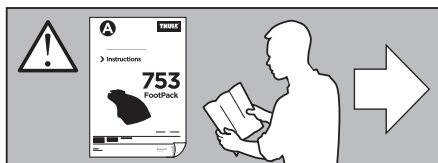
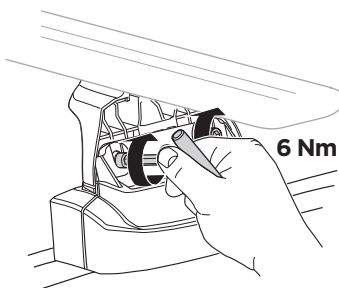
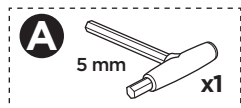

4



751
FootPack

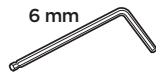
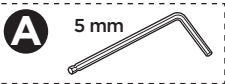

A

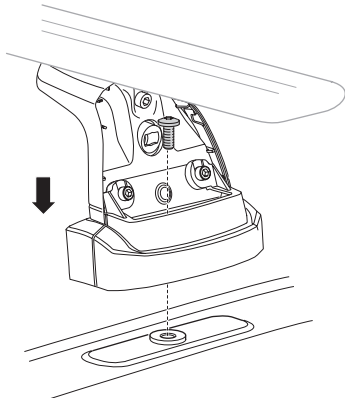

B

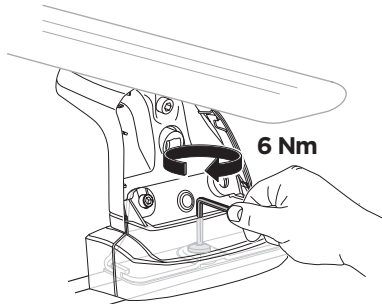
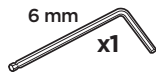

C

