

# 1

## Kit 145324

**FORD Ranger Crew Cab**, 4-dr Pickup, 23-/\*24-  
**FORD Ranger Raptor Crew Cab**, 4-dr Pickup, 23-/\*24-  
**FORD Ranger Super Cab**, 4-dr Pickup, 23-/\*24-  
**VOLKSWAGEN Amarok**, 4-dr Pickup, 23-

\*North America



ISO 11154-E

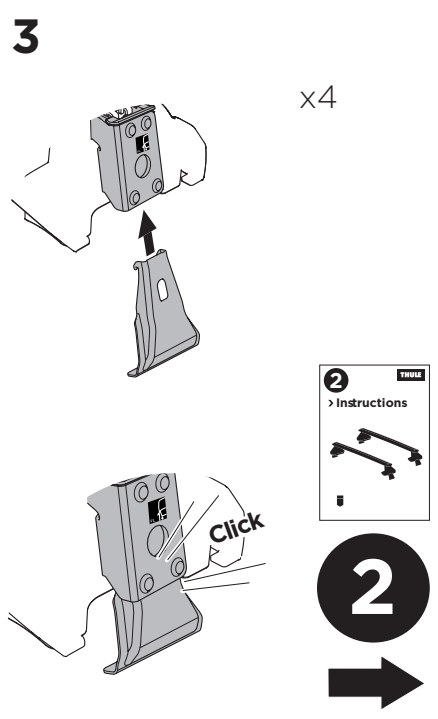
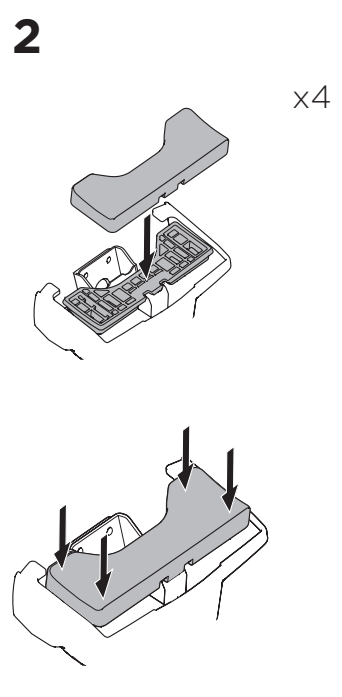
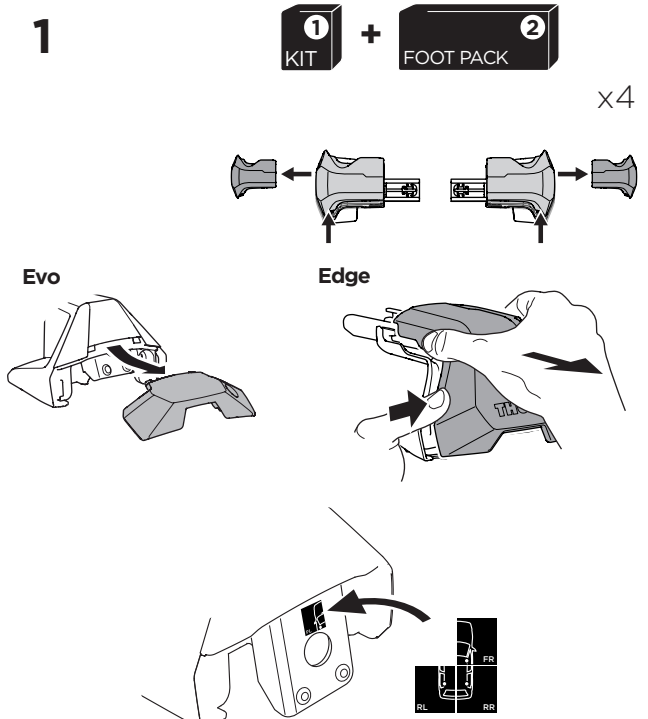
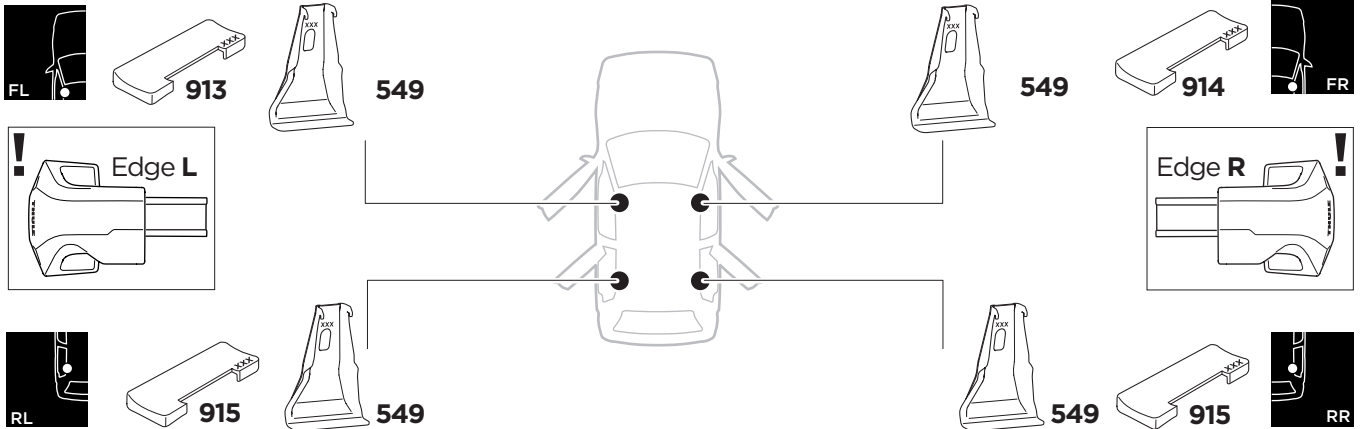
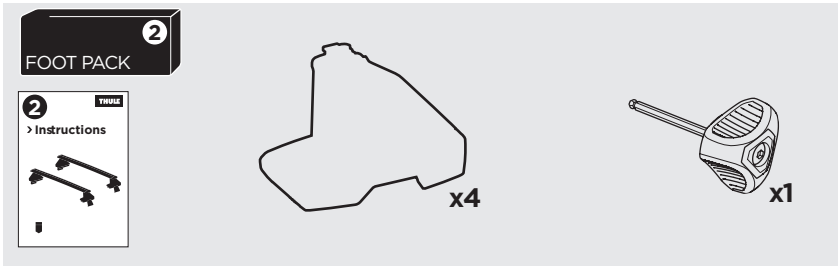
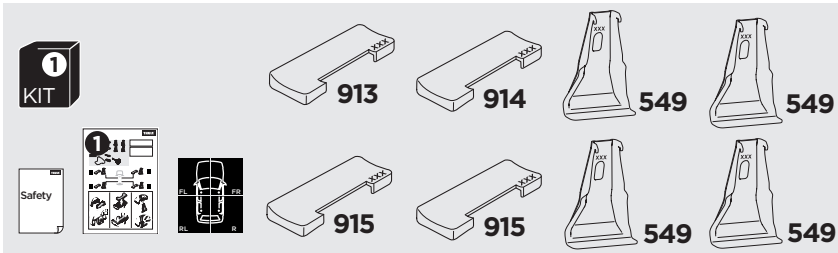

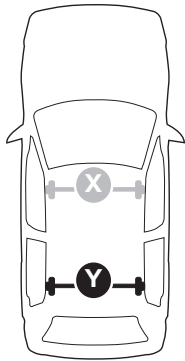
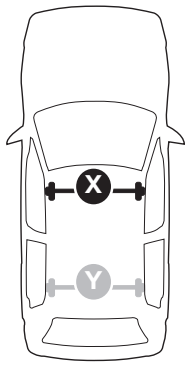

THULE WingBar Evo            THULE WingBar Edge            THULE WingBar            THULE SquareBar Evo	Evo Y (scale)	Edge Y (scale)
FORD Ranger Crew Cab, 4-dr Pickup, 23-/*24-	48	A
FORD Ranger Raptor Crew Cab, 4-dr Pickup, 23-/*24-	48	A
FORD Ranger Super Cab, 4-dr Pickup, 23-/*24-	48	A
VOLKSWAGEN Amarok, 4-dr Pickup, 23-	48	A

THULE ProBar Evo            THULE SlideBar Evo	Y (mm/inch)
FORD Ranger Crew Cab, 4-dr Pickup, 23-/*24-	1131 mm / 44 1/2"
FORD Ranger Raptor Crew Cab, 4-dr Pickup, 23-/*24-	1131 mm / 44 1/2"
FORD Ranger Super Cab, 4-dr Pickup, 23-/*24-	1131 mm / 44 1/2"
VOLKSWAGEN Amarok, 4-dr Pickup, 23-	1131 mm / 44 1/2"

THULE WingBar Evo            THULE WingBar Edge            THULE WingBar            THULE SquareBar Evo	Evo X (scale)	Edge X (scale)
FORD Ranger Crew Cab, 4-dr Pickup, 23-/*24-	48,5	R
FORD Ranger Raptor Crew Cab, 4-dr Pickup, 23-/*24-	48,5	R
FORD Ranger Super Cab, 4-dr Pickup, 23-/*24-	48,5	R
VOLKSWAGEN Amarok, 4-dr Pickup, 23-/	48,5	R

THULE ProBar Evo            THULE SlideBar Evo	X (mm/inch)
FORD Ranger Crew Cab, 4-dr Pickup, 23-/*24-	1136 mm / 44 3/4"
FORD Ranger Raptor Crew Cab, 4-dr Pickup, 23-/*24-	1136 mm / 44 3/4"
FORD Ranger Super Cab, 4-dr Pickup, 23-/*24-	1136 mm / 44 3/4"
VOLKSWAGEN Amarok, 4-dr Pickup, 23-	1136 mm / 44 3/4"

	W (mm/inch)	Z (mm/inch)
FORD Ranger Crew Cab, 4-dr Pickup, 23-/*24-	700 mm / 27 1/2"	310 mm / 12 1/4"
FORD Ranger Raptor Crew Cab, 4-dr Pickup, 23-/*24-	700 mm / 27 1/2"	310 mm / 12 1/4"
FORD Ranger Super Cab, 4-dr Pickup, 23-/*24-	600 mm / 23 5/8"	310 mm / 12 1/4"
VOLKSWAGEN Amarok, 4-dr Pickup, 23-	700 mm / 27 1/2"	310 mm / 12 1/4"

